

# B.E.G. LUXOMAT® PD4-M-DALI/DSI-HVAC/PD4-S

## Installation and Operating Instruction for B.E.G. - Occupancy detector PD4-M-DALI/DSI-HVAC-DE

### 1. Product information

- For group operation of up to 50 lights
- Suitable for dimmable digital electronic ballasts and control moduls
- One additional switching channel (NO potential-free, dry) for controlling lights and HVAC (heating, ventilation, air conditioning) devices
- DALI/DSI interface
- Constant light control
- Manual switching / dimming
- Full or semi-automatic mode
- Set value brightness, follow-up time – LIGHT/HVAC and orientation light adjustable
- Sensor and power supply in one housing
- Infrared remote control

### 2. Operation

The presence detector controls the light automatically according to people present (movements) and the ambient brightness.

The integrated light sensor constantly measures the ambient light and compares it with the brightness level on the detector. If the ambient light is sufficient, lighting will not be switched. If the ambient light level is below the brightness level, a movement activates the lighting in the room.

The detector switches the light off, if there is enough natural light for 5 min. or if no movement is detected for one follow-up time.

The second channel can be interpreted as HVAC channel (heating, ventilation, air conditioning). This channel switches the connected load independent of the brightness.

### 3. Safety advice

**Work on the 110-240V mains supply may only be carried out by qualified professionals or by instructed persons under the direction and supervision of qualified skilled electrical personnel in accordance with electrotechnical regulations**

**Disconnect supply before installing!**

**This device is not suitable for disconnection.**

**After having connected all cables, please mount the cap onto the detector.**

### 4. Mounting FC

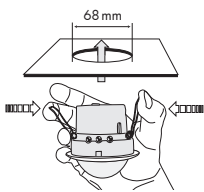

A circular opening of diameter 68 mm must be drilled into the ceiling. Having connected the cables in accordance with regulations, the detector is inserted into the opening as shown in the drawing above and has to be fixed into position by means of the spring clips.

**In Master/Slave operation, the master device must always be installed at location with least daylight.**

### 5. Position DIP switches, LEDs and potentiometers

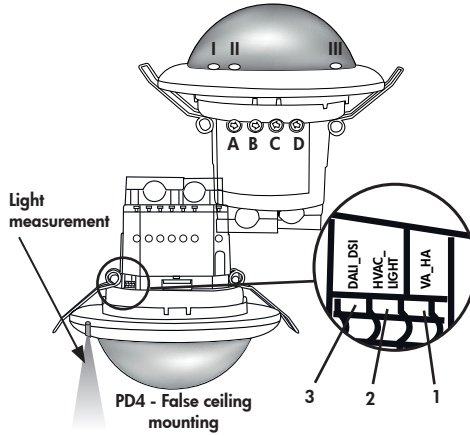

### 6. Self test cycle/Startup behavior

The product enters an initial 60-second self-test cycle, when the supply is first connected. During this time, the device does not respond to movement and stays on.

The initialization mode can be changed by using the remote control.

### 7. Putting into operation / Settings

**Twilight-switch for constant light control**  
The set value brightness can be adjusted at between 10 and 2000 Lux. Using the potentiometer, the set value brightness can be adjusted as desired.  
Symbol Night-time operation  
Symbol Day/night time operation

**Follow-up time for light control**  
The time can be set infinitely variably between 1 and 30 minutes.  
Symbol **TEST**: Test mode  
Every movement switches on the light independent of brightness for a period of 1 second, switching it off for a period of 2 seconds.

**Orientation light**  
The follow-up time can be set infinitely variably at between 5 and 60 minutes. Manually switching ON/OFF the orientation light.  
„ON“ for permanent orientation light  
„OFF“ for deactivation of orientation light

**Follow-up time for device control**  
The follow-up time can be adjusted between 5 min. and 120 min. The delay is active from a set time of >15 minutes. This delay is about 5 min. If no other movements are detected during this time, the delay starts again.

**Impulse function**  
The impulse function can be used to control external HVAC systems. All 9 s will be set a 2.5 sec.

**Alarm impulse**  
In order to initiate an alarm impulse, there have to be three detected movements within a period of 9 sec.  
This function can be used to display a presence in the room on external visualizations. All 9 sec. will be set an impulse of 2.5 sec.

The device does not fulfil the requirements of DIN EN50131-22 and therefore cannot be used in professional intrusion detection systems.

**Pulse spacing PD-Slave**  
2 or 9 seconds can be set for the pause between 2 pulses sent to the master. The setting can be made with activated () or deactivated () LED indicator.  
For devices with a separate slave input, 2 sec. can be set.

DIP switch functions		
DIP 1	Fully automatic mode (VA)	Semi-automatic mode (HA)
DIP 2	HVAC function	Light control*
DIP 3	Operation mode DALI	Operation mode DSI

\*If you select „LIGHT“, the switching relay R2 operates synchronously to the DALI light channel. The potentiometer R2 has no function in this setting.

**Potentiometer A** Lux Channel 1

**Potentiometer B** Time Channel 1

**Potentiometer C** Orientation light

**Potentiometer D** HVAC Channel 2

LED I green

LED II red

LED III white

### 8. Wiring diagram

Standard mode with Master/Slave

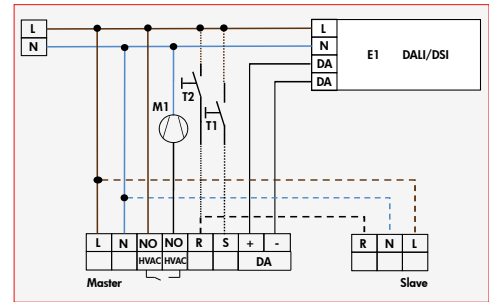

### 9. Manual switching and dimming

By pressing the push button, the phase can be given to the S terminal.

To turn on or off, press the push button briefly. The light will remain on or off, as people are detected plus the follow-up time.

With a long key press the light will be dimmed manually. When you release the button, the current brightness value is retained. Upon renewed dimming, the dimming direction is reversed.

Taking the phase to the R terminal by using a button, the HVAC channel can be switched with a short key press.

### 10. Range

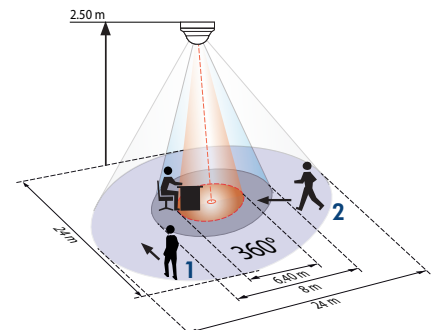

- 1 walking across
- 2 walking towards
- 3 seated

**Connected slaves must have the same phase as the Master.**

## 11. Exclude sources of interference

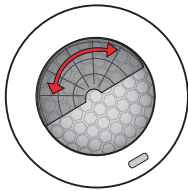

If the detection zone is too large, or areas are covered that should not be monitored, use the blinds to reduce or limit those areas.

## 12. Technical data

Sensor and power supply in one case

<b>Power supply:</b>	110-240 VAC, 50/60 Hz
<b>Power consumption:</b>	ca. 1 W
<b>Ambient temperature:</b>	-25°C to +50°C
<b>Degree of protection/class:</b>	IP20 / II
<b>Recommended height for mounting:</b>	2 - 3 m
<b>Range of coverage Ø</b>	
<b>H 2.5 m / T = 18°C:</b>	seated 6.4 m / tangential 24 m / radial 8 m
<b>Area of coverage:</b>	circular 360°
<b>Dimensions H x Ø [mm]</b>	FC 103 x 97 mm
<b>Visible part when built into ceiling:</b>	30 x 97 mm
<b>Lux value:</b>	10 - 2000 Lux

- **DALI/DSI**  
digital BUS control wire, 2-core, no polarity (broadcast only)
- Max. no. of series-connected electronic ballasts:**  
up to 50
- Time settings:**  
• **Channel 2**  
1 - 30 min. / test
- Type of contact:**  
NOC / with pre-travel tungsten
- Contact load:**  
2300 W,  $\cos\phi = 1$ ;  
1150 VA,  $\cos\phi = 0.5$ ,  $\mu$  contact

## Technical data PD4 Slave

<b>Power supply:</b>	110-240 VAC, 50/60 Hz
<b>Impulse output:</b>	Optocoupler max. 2 W
<b>Impulse duration:</b>	2 sec. or 9 sec.
<b>Dimensions:</b>	see above

CE Declaration of Conformity: The product complies with the low voltage recommendation 2006/95/EC and the EMV recommendation 2004/108/EC.

## 13. Article / Part nr. / Accessory

Type	FC
PD4-Master-DALI/DSI-HVAC	92699
PD4-Slave	92254

<b>LUXOMAT® Remote control:</b> IR-PD-DALI-1C (incl. wall bracket)	92116
<b>Accessories:</b> BSK Wire basket	92199

## 14. LED function indicators

LED function indicators		
Process	Standard mode	Double locked
Initialisation time unprogrammed	red flashes	green flashes
Initialisation time programmed	red flashes quickly	green flashes quickly
Motion detection	red flashes on each detected movement	green flashes on each detected movement
Too bright detected	red flashes 2x per second	green flashes 2x per second
Too bright / too dark / undefined in opened state	red flashes very quickly	green flashes very quickly
Toggle DALI/DSI DSI active	red shines 3 sec.	
Toggle DALI/DSI DALI active	green shines 3 sec.	
Toggle HA/VA VA active	red shines 3 sec.	
Toggle HA/VA VA active	green shines 3 sec.	
Toggle Preset/User Preset active	red shines 3 sec.	
Toggle Preset/User User active	green shines 3 sec.	
IR signal valid received	red and white shines 3 s	
IR signal invalid received	red shines 0,5 sec.	
100 h function active	red / green flashes variable	red / green flashes variable

## 15. Putting into operation of the remote control IR-PD-DALI-1C (optional)

⚠ Settings with remote control override the potentiometer and DIP settings.

The DIP settings are reactivated by

- Setting the potentiometers to "TEST" and "SUN", or
- Pressing the "Reset" button on the remote control in open state

### Remote control LUXOMAT® IR-PD-DALI-1C

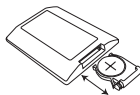

#### 1. Check Battery:

Open battery compartment by pressing the plastic springs together and removing the battery-holder.

#### 2. Note:

Using the remote control, the occupancy detector can only be operated in dependence on brightness. The setting "SUN" can only be set with potentiometer A.

By using the remote control IR-PD-DALI-1C, we recommend to set potentiometer A on "SUN". Pushing the RESET button (remote control) would reset the brightness independence of the occupancy detector (SUN).



IR-PD-DALI-1C



Wall bracket for remote control IR-PD-DALI-1C

## 16. Settings by remote control in open state

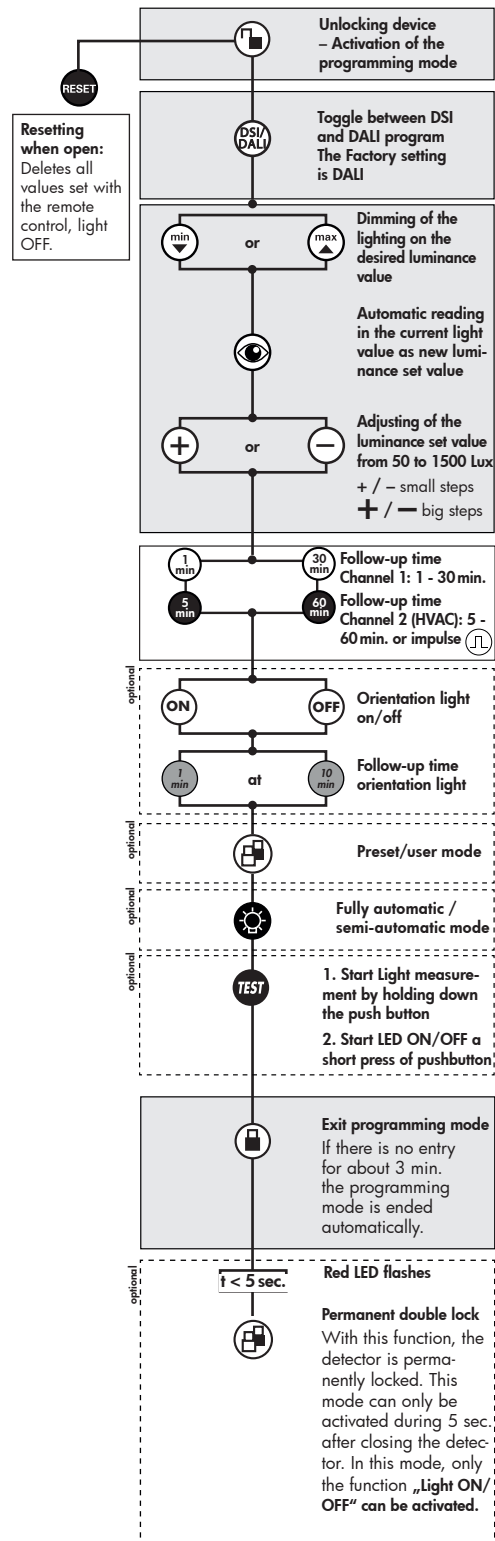

## 17. Light regulation

The detector integrated two different light control algorithms. The set value for the first algorithm is adjusted by potentiometer (LUX) on the device. Very small light amounts, which shine directly to the detector, have the result of a trigger under control of the set value.

The second algorithm has an integrated daylight compensation. Therefore, it is necessary that the detector analyses the switched light quantity. This algorithm can only be used by remote control. The programming of the set value and the measurement of the light quantity is carried out in two steps:

### In the open state

- The set value will be adjusted without daylight (please darken the room) by using the remote control.
- Measuring the light quantity will be initiated by a long press (> 3 sec) of the test button. The detector turns the light on for 5 min. at 100%. Then the light will turn off and on for a short time and stays on after that. This measuring process is shown by a flashing green LED (10 sec off / 1 sec on). This measuring process is required for every change of the set value.

If the measuring process is not performed, the detector performs it automatically when the ambient light is less than 50 LUX for 1 h.

## 18. Fully automatic/ Semi-automatic mode

The mode is changed using the button "Light" in the open state. Each time the button is pressed, the current operating mode is indicated by the LEDs:

- Red lights for 3 sec. = Fully automatic mode
- Green lights for 3 sec. = Semi-automatic mode

### Fully automatic mode

In this operating mode, the lighting switches on and off automatically for increased comfort depending on presence and brightness.

### Semi-automatic mode

In this operating mode, the light turns on only after a manual switching, for an increased savings success. Switching off is automatically or manually.

The semi-automatic mode basically behaves like the fully automatic mode. The only difference is that the switching on has to be done by hand, always!

## 19. Settings during the Self-test cycle

In the first 60 seconds after connecting the AC voltage, the following functions can be set:



### INI-OFF/ON mode:

Turn off or turn on the detector during the self-test cycle of 60 sec. The final state is active. Factory setting is that the light is on during initialization.



In the mode INI-OFF, the detector does not turn on after connection to mains. Even movement switches the detector on only after 60 sec.



### Startup behavior:

The set value can be reached in two ways after switching on. The detector switches the lights on at 10% and then adjusts upwards (min button) or it switches the light on at 100% and regulates down (max button). This is confirmed by a short flashing of red and white LEDs as well as the lighting. By factory default setting, the detector switches the light on at 100%.



## 20. Self-test cycle/Reset



### Test mode

"TEST" button for activating the test mode, "Reset" button for deactivating it.



### Resetting when closed

The lighting is switched off, and the follow-up times are reset.

## 21. 100 h function

(long press when closed)

T5 and T8 are recommended to burn-in for 100 h at maximum brightness before dimming. This would prolong the life of the lamp.

In the 100 h function mode, the detector only switches on and off. A dimming to the set value will be suppressed. The lamp has to burn for 100 h, until the set value gets regulated.

The 100 h function will be activated by pressing the button longer (>3 sec.). An activated time can be stopped by a long press of the button again. The red / green LED indicates if the function is activated.



Before any dimming is possible, the dimming function is suppressed for 100 h at T5 or 80 h at T8 fluorescent lamps. They have to burn in at 100%.

Failure to comply to the 100 h burn-in would lead to reducing the life of the lamp. Unwanted random variations in light intensity can be the result.

## 22. Manual Switching

(short press when closed)

You can switch the lighting on and off manually by pressing the button for a short time. It will stay on or off as long as people are detected plus the configured follow-up time.

## 23. Manual Dimming – Preset/User

Manually dimming with external pushbutton - You can dim manually by pressing the push button for a long time (> 2sec.). When the button is released, the current dimming value is retained. Upon renewed dimming, the dimming direction is reversed.



Two different operating modes can be selected in the open state.

The button "Doublelock" is for toggling between the modes. Each time the button is pressed, the current operating mode is indicated:

- Red lights for 3 sec. = Preset
- Green lights for 3 sec. = User

**PRESET** – the set value brightness is adjusted during start-up operation by the installer and remains unchanged. The set value brightness configured through manual dimming is only applied for the time being.

The constant light regulation is now deactivated!

The current set artificial light level is maintained independent of the ambient/daylight brightness! After switching off and then on again, the originally adjusted set value brightness is reset = constant light regulation is activated.

### USER

The set value brightness is changed upon each manual dimming and is re-adjusted by the user. The constant light regulation remains activated!

## 24. Reset the detector

The double lock being activated, the detector can be reset (deactivation of the double lock) as follows:

- Disconnect operating voltage
- Connect operating voltage for 31 to 59 secs.
- Disconnect operating voltage again
- Connect operating voltage again and wait for the self testing
- Open detector

With this procedure, the remote control programmed values are not deleted (before activation of the double lock).

Alternatively, the detector can be reset in this way:

- Disconnect operating voltage
- Set potentiometer B to "TEST" and potentiometer A to "SUN"
- Connect operating voltage

Except of the INI ON/OFF setting, the detector will be reset to factory settings or the settings of the potentiometers.

Pushing the "RESET" button on the remote control in open state will delete all of the values which were set by means of the remote control (except of INI ON/OFF) and set the detector back to factory settings.