

B.E.G. LUXOMAT® FL2N-LED floodlights

Operating and mounting instructions for LED floodlights FL2N-LED/FL2N-LED-230 (with 230° motion detector)

1. Product information

- Floodlight with LED technology
- suitable for outdoor installation
- sturdy housing made of die-cast aluminium with corrosion-resistant stainless-steel screws, socket made of UV-resistant polycarbonate
- FL3N-LED-230 with integrated 230° motion detector
- FL3N-LED without motion detector (disregard pt. 6-9)

2. Function

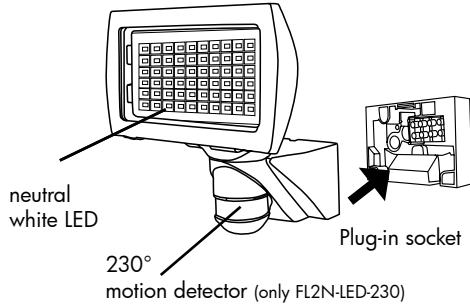

The LED-floodlights LUXOMAT® FL2N-LED-230 are suitable for outdoor use. They possess a solid, water and dust resistant housing of diecast aluminium with corrosion-resistant stainless screws.

There are numerous application examples, for instance for lighting of inner rooms, car parks, lawn, shopping center, tunnel aso.

3. Warning notices

- The lamp housing heats up during operation. Only carry out alignment of the LED head when it cooled down.
- Do not look from a short distance or a long period in the floodlight. This can lead to severe damage of the retina.
- Before starting disconnect the mains!
- Have all work involving the 230V mains supply carried out by a qualified electrician!

4. Mounting preparations

Please pay attention to the following instructions before the installation:

- This appliance is only suitable for fixed mounting.
- Respect a minimum distance of 0.3 meter between the appliance and object or surface which has to be lit.
- The installation has to be made according to current wiring regulations.
- Replace cracked protection glass immediately in order to avoid a damage of the LED floodlight

Attention: No maintenance work on floodlight head

5. Montage

Installation guidance

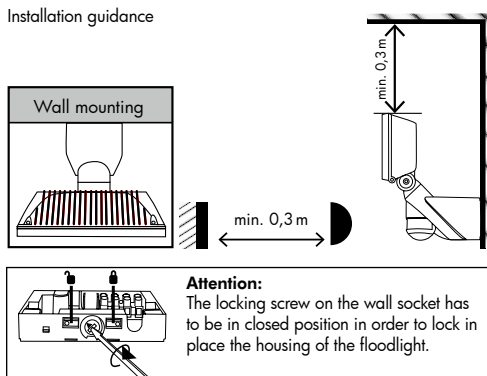

6. Putting into operation / Settings

Self test cycle

After mounting and connecting the 230 VAC supply voltage, the LED flashed for 1 min. to show a self testing unit. Then the unit is ready for operation and the settings can be made manually or with remote control (see point 18).



- 1) Remove the covering with slightly pressure
- 2) Adjust Range, follow-up accommodation and Lux value with screwdriver



Mechanical range adjustment
+ : e.g. 20 m, - : e.g. 5 m (mounting height 2.50 m)
mounting height min. = 2.00 m
(2 zones, see point 9)



Follow-up time
Test operation, 15 sec. ... 16 min., Pulse operation
(Test operation: range testing, detector switches on/off the lighting at any recognized movement)

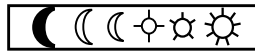

Lux value
Night operation...Dusk...Day operation
(Day operation: light sensor inactive, switching at any brightness value)

LED Functional display
Display of movements and operating states
(Switchable with remote control LUXOMAT® IR-RC, see point 18)

7. Factory settings



On delivery the potentiometers are adjusted in position "TEST" and "SUN" symbol (daytime operation). With this adjustments the following regular values are active:

Follow-up accommodation: 3 min.
Lux value: approx. 20 Lux

Reset: The adjusting into "Factory settings" from any other position causes a "Reset" of the device. That means all parameters are resetted into factory settings (fast LED-flashing).

8. Sensor head optics

Change range or sensitivity adjustments by swivelling of the sensor head vertically or horizontally
(Sensor head horizontally = max. range)

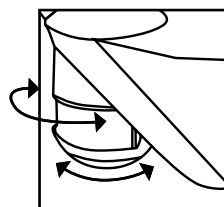

9. Sensitivity adjustment (mounting height 2.50 m); mounting height min. = 2.00 m

(Sensor head justified horizontally, see point 8)

Mechanical range adjustment possible for every zone separately (see point 8)

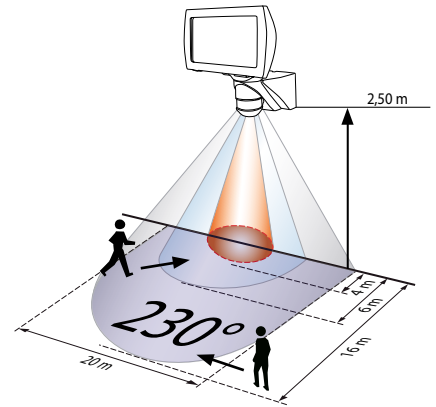

10. Exclude sources of interference

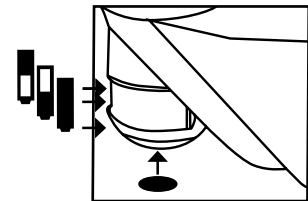

- 1) Push in cover-up clips on marked place (blind out distant range/close-up range/both)
- 2) Cover-up stickers

11. Free rotation of floodlight head in three levels

A) Vertical

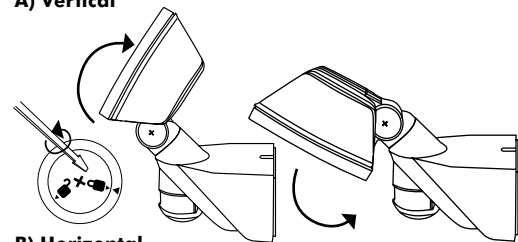

B) Horizontal

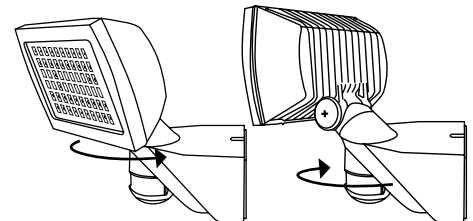

C) Swivelling up- and downwards

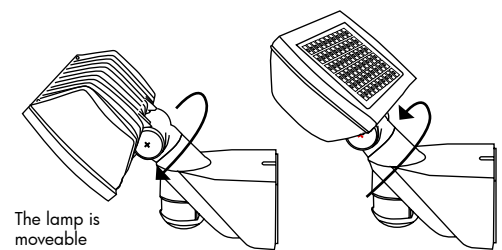

The lamp is moveable in 180° to allow wall uplighting

12. Wiring diagrams

The installation has to be made according to current wiring regulations.

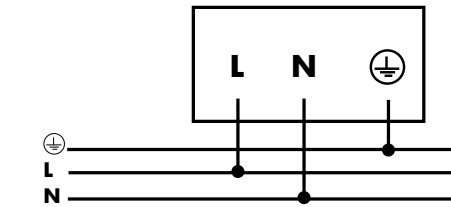
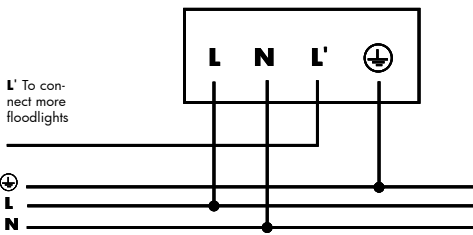

13. Dimensions (mm)

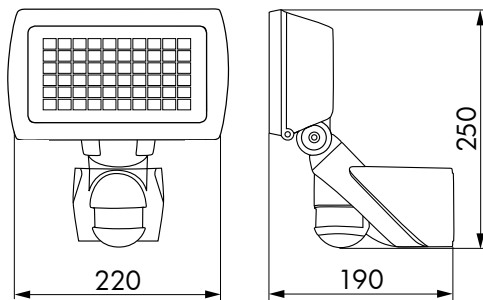

14. Article / Part nr. / Accessory

Type	Colour	Part nr.
FL2N-LED-230	black	92626
FL2N-LED-230	white	92627
FL2N-LED	black	92598
FL2N-LED	white	92599

LUXOMAT® Remote control (FL2N-LED-230):

IR-RC (incl. wall bracket)	92000
IR-RC-Mini	92090

Accessory:

Arc extinction kit (FL2N-LED-230)	10880
Diffusing lenses	38003

For an optimum illumination, **B.E.G.** offers diffusing lenses which can easily be clipped on the floodlight.

16. Technical data

Power supply: 110-240 VAC, 50/60 Hz

Material: detector UV-stabilised Polycarbonate, housing floodlight of diecast aluminium

Optic: Covering globe of clear glass

Lamp: LED board fixed mounted

Total power consumption: 26 W

Light colour: ca 4000 K, neutral white

Light output: 2100 lm

Energy efficiency class: A

Degree of protection/class: IP44 / I / CE

Ambient temperature: -20° C to +40° C

additional PIR motiondetector in FL2N-LED-230

Switching power: 2300 W, $\cos \varphi = 1$

1150 VA, $\cos \varphi = 0,5\mu$

Range (motion detector): max. 10 m

Time settings: Impuls, 30 sec. - 30 min.

Photo electric switch: approx. 2 - 2000 Lux

Detection area: 230°

CE Declaration of Conformity:

This product respects the directives concerning

1. electromagnetic compatibility (2004/108/EU)
2. low voltage (2006/95/EU)
3. restriction of the use of certain hazardous substances in electrical and electronic equipment (2011/65/EU)

Additional note:

LED can not be replaced.

You have chosen a quality product that has been produced and tested with utmost care. Even if up to 2 LEDs fail, the indicated value of light output is achieved nevertheless. Therefore, guarantee cannot be claimed in this case

17. Settings of remote control

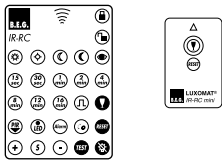

- 1) LUXOMAT® IR-RC (accessory, see point 14)
- 2) LUXOMAT® IR-RC-Mini (accessory, see point 14)

Caution: Settings with remote control override the potentiometer settings (see point 6) (for description see point 18).

18. Functions of LUXOMAT® IR-RC

Unlocking device

Lux value: Day operation
light sensor inactive, switching at any brightness value

Lux value: approx. 100 Lux
Onset of dusk

Lux value: approx. 25 Lux
Advanced dusk

Lux value: approx. 2 Lux
Darkness

Automatic reading in the current light value
Individual light value
2 - 2000 Lux

Follow-up time
15 sec. upto 16 min.

Impulsfunction (see note ①)
1 sec. ON, 9 sec. OFF

Anti-creep protection
Switching ON/OFF

Walk test
Switching ON/OFF

Alarm function
Switching ON/OFF,
(ON for 30 sec., OFF for 1 sec., then normal operation)

Vacation- and comfort function
Switching ON/OFF
On: By achieving the Lux value 1 hour daylight independent of movements, then normal operation (switching time changeable, see point 21)

Sensitivity adjustment
~ +15 %, ~ -30 %

Reset
Erasing of all of the values set using the remote control. (Then potentiometer-settings activ, see point 6.)

Lock device

Double Locking (sabotage protection)
Locking of IR-RC-reception. After locking the device press "Locking" again during a period of 5 sec. (reset see point 7)

Test operation
Switches the light ON/OFF when movement is detected.

Light ON for 12 h / Light OFF for 12 h
By pressing once the party button, the light is switched on for a period of 12 hours. By pressing the party button twice, the light remains switched off until the next evening (see point 19).

Light OFF
Switches the light ON again when movement is detected.

Reset
Light OFF, then automatic mode

Caution: The infrared receiver of the detector is positioned in the anti-creep protection. For best reception target anti-creep with remote control.

19. Functions of LUXOMAT® IR-RC-Mini

Light ON for 12 h / Light OFF for 12 h
By pressing once the party button, the light is switched on for a period of 12 hours. By pressing the party button twice, the light remains switched off until the next evening (see point 18).

Reset
Light OFF, then automatic mode

20. Activation "Light OFF"

Because of the sabotage protection the function "Light off" is deactivated in the factory. When required it must be activated again:

1. Mains to be disconnected
 2. Mains to be connected - a self test cycle of 60 sec. starts (the LED is flashing, see point 6).
 3. Activation/deactivation of the function "Light Off" can be done only during the self testing cycle
- For activation of the function "Light OFF" the button "Light OFF" must be pressed during the self testing cycle (the LED will flash quickly).
- For deactivation "Light OFF" the button "Reset" must be pressed during the self testing cycle (the LED will flash slowly).

Caution: The implementation of "Reset" with potentiometers (see point 5) or with remote control (see point 18) does not influence the activation/deactivation of the function "Light OFF"

21. Vacation- and comfort function

The duration of the on-period can be adjusted:

1. "Unlock" unit with remote control
2. The button "Co" to be operated. The LED flashes for 10 sec.
3. During these 10 seconds the duration of the light-on period can be selected: from e.g. 15 sec. = 15 min. up to 16 min. = 16 hrs
4. The unit to be locked with the button "Lock".
5. "Vacancy/Comfort" is active now (deactivation see point 7)

Caution: If the "Vacation- and comfort function" is active or with lower deviation of the Lux value the motion detector turns on the light again after a time delay of 60 sec.

22. Follow-up time savings

The energy saving and comfort by courtesy of follow-up accommodation of the motion detector is unique. That means: If the last detected movement is located in the anti-creep zone (for instance mounting over a doorway), the follow-up accommodation will be reduced to 1/4 of the original time = energy saving.

F.ex.: adjusted follow-up accommodation = 16 min.

- a) walking towards unit: effective follow-up accommodation = 4 min.
- b) walking away from unit: effective follow-up accommodation = 16 min.

Caution: The "dynamic follow-up accommodation" will be activated or deactivated on following conditions:

Follow-up accommodation "active":

- > Unit is located in "factory settings" (see point 7)
- > Settings of follow-up accommodation with remote control values 15 sec. - 16 min. (see point 18)

Follow-up accommodation "inactive":

- > Settings of follow-up accommodation with potentiometers values 15 sec. - 16 min. (see point 6)

- ① As soon as the function "Chime/Impulse" is activated, the following functions will be blocked: Alarm function, Light ON for 12 hrs / Light OFF for 12 hrs, Vacation- and comfort function