

Installation and Operating Instruction for B.E.G. - Occupancy detectors PD9-M-1C+HVAC

1. Mounting preparations

Work on the 230V mains supply may only be carried out by qualified professionals or by instructed persons under the direction and supervision of qualified skilled electrical personnel in accordance with electrotechnical regulations.

Disconnect supply before installing!

When in Master/Slave mode of operation, the Master-appliance must always be installed at the location where there is least daylight.

2a. Installation

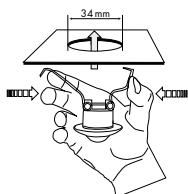

The detector has been designed and developed specifically for installation in suspended ceilings.

A circular opening of diameter min. 34 mm must be produced in the ceiling.

Having connected the cables in accordance with the regulations, connect the power supply via the RJ12 plug. Therefore, open the power supply with the help of the screws and close it afterwards. After that, put the power supply through the opening in the ceiling and mount the sensor onto the ceiling according to figure.

2b. Connecting terminals



2c. Self test cycle

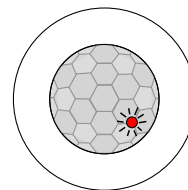

The LUXOMAT® PD9-M-1C+HVAC enters an initial 60-second self-test cycle, when the supply is first connected. The occupancy detector is ready for operation.

3. PD9-M-1C+HVAC: Settings carried out using remote control (optional)

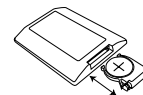

Remote control LUXOMAT® IR-PD-2C

1. Check Battery: Open battery compartment by pressing the plastic springs together and removing the battery-holder.

Option:

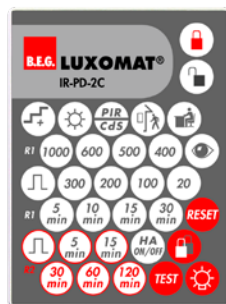

IR-PD-2C - 92475



Wall bracket for remote control IR-PD-2C

An adhesive film for the surface of the IR-PD-2C is included with the device. If required, this can be used for any B.E.G. remote control with 27 keys.

In order to benefit from the whole range of functions of the PD9-M-1C+HVAC, please order separately the remote control IR-PD-2C.

4. Settings by remote control IR-PD-2C

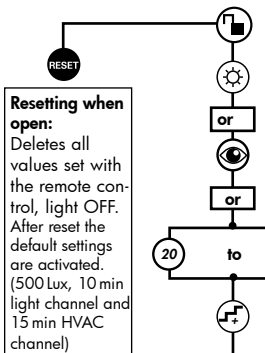

Unlocking device – Activation of the programming mode

Daytime operation, detector only activated by motion

Automatic reading in the current light value as new luminance set point

Luminance set point for channel 1
20 - 1000 Lux

Increase the current light level by
20 resp 50 Lux

Change between motion detector and photo electric switch

Follow-up time channel 1 (light)
5 - 30 min. or impuls

Follow-up time channel 2 (HVAC)
5 - 120 min. or impuls

Detection sensitivity reduced or normal

Change between fully automatic and semi automatic mode (HA)

Light ON/OFF

LED ON/OFF (by holding down the push button)

Locking device – Exit programming mode
The device is not suited for safe disconnection of the mains supply
white LED flashes

Permanent protection against sabotage

5. Key functions in closed state

Permanent protection against sabotage
This function blocks the unit permanently. This operating mode can only be activated during the period of 5 seconds (white LED flash) after pressing the "Lock" button. The procedure for leaving this mode is as follows:

1. Switch off the current
2. Apply current for 31 - 59 seconds
3. Switch off the current again
4. Apply current, wait for selftest cycle
5. Open detector

Light ON/OFF during the detection of motion plus follow-up time; Activation of the 12 h-ON/OFF-function by holding down the push button

TEST
Activation/Deactivation of the test function

RESET
Switches channel off and is immediately active again, exits all timers, interruption of light measurement

Confirmation

Changes to "open" state

6. Exclude sources of interference

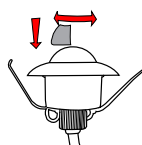

In case the sensing area of the LUXOMAT® PD9-M-1C+HVAC is too large or areas are being covered that should not be monitored, the range can be reduced or limited through use of the enclosed masking clips.

7. Range of Coverage

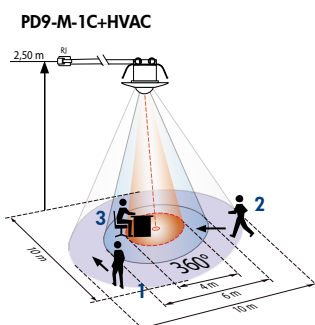

- 1 Walking across
- 2 Walking towards
- 3 Seated

8. Dimensions

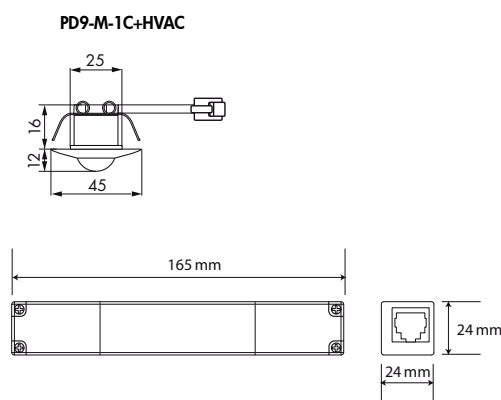

9. Explanation of the remote control button functions

9 a. In the initialisation period



12 h Light ON/OFF (party function)

Activated by "Light" - push button



Deactivated by "Reset" - push button (default)



Corridor function (see point 11a)

Activated by "30 min" - push button - R2



Deactivate by "60 min" - push button - R2 (default)



Forced shutdown (see point 11c)

Activated by "impulse" - push button - R2



Deactivate by "5 min" - push button (default)

9 b. In opened state



This push button opens the detector and the following functions can then be programmed.

Attention: The detector is closed automatically:

- after every voltage recovery
- after 3 minutes



The state changes to "closed".
In the first 5 seconds, the white LED flashes every 0.5 seconds. During this time, sabotage protection can be activated.



The device distinguishes between 2 procedures:

- **Reading in with lighting switched on:**
The switch-on value is determined automatically.

Determining the switch-on value:

1. Press the "eye" push button
2. Switch off the light (2 seconds later)
3. Read in the brightness
4. Switch-on value = Read brightness

- **Reading in with lighting switched off:**

When the push button is pressed, the current brightness is specified as the switch-on value. The switch-off value is determined automatically.



If the brightness has been modified, the switch-off threshold is recalculated.



Each time the push button is pressed, the device increases the current switch-on value in increments of 20 lux for a current switch-on value of < 100 lux and in increments of 50 lux for a current switch-on value of > 100 lux.



Standard sensitivity for most applications



Reduced sensitivity for outdoor applications



When the pulse function is active, a pulse of 1 sec. is generated every 9 sec. If the pulse function is activated via remote control, the pause between 2 pulses can be modified. After activating the function via the "Pulse" push button, select the desired time within 5 sec.:

$\left(\frac{5}{\text{min}}\right) = 9 \text{ sec.}, \left(\frac{10}{\text{min}}\right) = 10 \text{ sec.}, \left(\frac{15}{\text{min}}\right) = 15 \text{ sec.}, \left(\frac{30}{\text{min}}\right) = 30 \text{ sec.}$



The "Test" push button can be used to set the LED ON/OFF function. To do this, hold down the push button for 3 sec.

Please note that in the open state and in test mode, the LED indicators are always ON.



Twilight switch function (CdS)

If the CdS function is active, the detector acts as a simple twilight switch. Only the brightness can be set in this mode. Movements are no longer indicated by the red LED.

Push button acknowledgement:

Each push of a button is indicated by lamp acknowledgement and by the white LED.

"Light ON" status: OFF/ON (approx. 0.5 sec. each)

"Light OFF" status: ON/OFF (approx. 0.5 sec. each)



Change between fully automatic and semi automatic mode

10. Switch-off threshold brightness

1. If the switch-on threshold has been modified by the potentiometer or remote control, the switch-off threshold stored in the EEPROM is deleted and is then recalculated on the next activation.

Determining the switch-off value

1. Switch on for 5 min. with dark and motion
2. Light OFF for 2 sec.
3. Internal calculation of the switch-off value

2. If the eye push button is pressed, the switch-off threshold is recalculated. See also Remote control-> Eye section 

3. Switch-off delay

If the determined switch-off threshold is exceeded during operation, the detector only switches off after a delay of approx. 15 minutes. This compensates for any brief fluctuations in the brightness.

11a. Behaviour of external push button/IR "Light"

The "Corridor" and "Light ON/OFF" functions are mutually exclusive. If both are activated, the detector performs the corridor function.

The behaviour when the push button is pressed is defined as follows:

Corridor function activated

Light ON:

Push button pressed briefly: Light OFF -> Active after 5 sec.

Push button held down: Light OFF -> Active after 5 sec.

Light OFF:

Push button pressed briefly: Light ON as long as motion + Lag time

Push button held down: Light ON as long as motion + Lag time

11b. Behaviour of external push button/IR "Light"

12 h Light ON/OFF activated

Light ON:

Push button pressed briefly: Light OFF -> Active after 5 sec.

Push button held down: 12 h OFF

Light OFF:

Push button pressed briefly: Light ON as long as motion + Lag time

Push button held down: 12 h ON

12 h Light ON/OFF deactivated

Light ON:

Push button pressed briefly: Light OFF as long as motion + Lag time

Push button held down: Light OFF as long as motion + Lag time

Light OFF:

Push button pressed briefly: Light ON as long as motion + Lag time

Push button held down: Light ON as long as motion + Lag time

11c. Behaviour of external push button/IR "Forced shutdown"

Forced shutdown active

Light OFF:

Light OFF: Push button pressed briefly: Light ON for approx. 30 min., then forced shutdown if the set brightness is still exceeded.

12. Other functions

Activation of light for 12 h via mains interruption

1. Interrupt current
2. Apply current for 2 to 5 sec.
3. Interrupt current again
4. Apply current
5. Detector is now ON for 12 h

Exiting sabotage

1. Interrupt current
2. Apply current for 30 to 60 sec.
3. Interrupt current again
4. Apply current
5. Detector is in simple closed state

230 V AC permanently at the slave input

If 230 V AC is applied at the slave input for longer than 10 sec., the light is switched on permanently. When the 230 V is removed, the light is switched off and automatic mode is activated.

230 V AC for 1 - 3 sec. at push button connection S

If 230 V AC is applied for 1 - 3 sec. at push button connection S, this is interpreted as a slave signal at slave connection R. This ensures that the detector is compatible with previous versions.

13. Full/Semi automatic mode

(see functions IR-PD-2C)

Fully automatic operation (presence)

In this operating mode, the lighting switches automatically on and off for increased comfort, depending on presence and brightness.

Semiautomatic operation (absence)

(semiautomatic can only be activated via the remote control)

In this operating condition, in order to gain increased savings, the lighting is energized only after being manually switched on.

Switch-off takes place automatically.

In semi-automatic mode, switching-on must always be carried manually.

As many (closer-contact) buttons as desired can be wired in parallel on the "S" button input (ON/OFF).

14. Wiring diagram

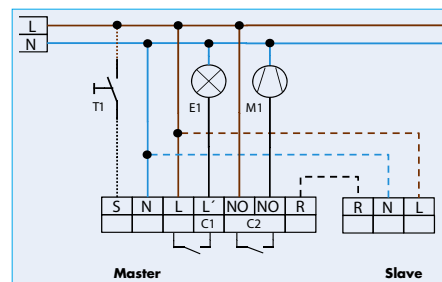

M1 = HVAC function

optional:

T1 = NO - Push button for semi automatic;
Extension of the detection area with Slave-devices

15. Connections

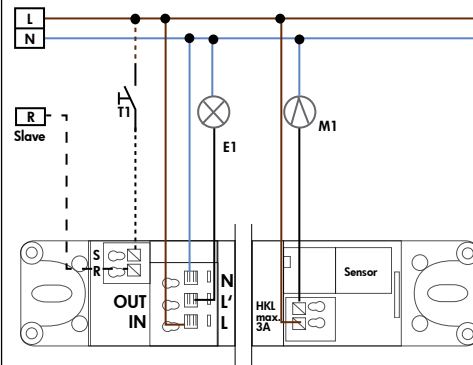

16. Article / Part-Nr. / Accessory

Type	RAL9010	RAL9006
PD9-M-1C+HVAC (Master)	92976	—
PD9-S-FP (Slave)	92905	92906

LUXOMAT® Remote control:

IR-PD-2C	92475
IR-PD-Mini	92159

Accessory:

Cover ring for PD9	white	92238
Cover ring for PD9	silver	92237
Cover ring for PD9	anthracite	92235

17. LED-functional indicators, fault-finding

The functional indicators in the case of the LUXOMAT® PD9-M-1C+HVAC (red and green LED's)

Red LED indicating self-checking mode (over a period of 60 seconds following mains'-supply lock-on)

Flashing at intervals of 1 second

EEPROM/memory empty

Flashing rapidly

EEPROM/memory contains information

Red LED as an indicator of status

Flashing irregularly

Movements are detected within the area of coverage

Flashing regularly

Detector identifies bright, light off

(dependent upon operating mode)

Not illuminated

Detector identifies darkness, light on

(dependent upon operating mode)

Flashing extremely rapidly

Too bright / Too dark / Undefined

Red LED as an acknowledgement of receipt for commands from the remote control

Illuminated for 2 seconds

Signal validly received

Illuminated for 0.5 seconds

Command not accepted, detector blocked

Flashing extremely rapidly

Command not accepted, occurs, for example, when an attempt is made to input twilight-value are too bright or too dark

Lights up for 3 seconds

Display automatic: Lights up for 3 seconds

Flashing for 3 seconds

Display semi automatic

Green LED as an indicator of status for

"Permanent protection against sabotage"

Flashing irregularly

Movement are detected within the area of coverage

Flashing regularly

Detector identifies bright, light off

(dependent upon operating mode)

Not illuminated

Detector identifies darkness, light on

(dependent upon operating mode)

Illuminated for 2 seconds

Signal validly received

(only possible for status "Light on/Light off")

18. Technical data

Connection of sensor and power supply by means of R J12

Power supply: 230V ~ ±10 %

Power consumption: < 1W

Degree of protection/class: IP20 / II

Settings: by remote control

Light values: 20 - 1000 Lux

Extension of the detection area: with Slaves

Area of coverage: circular 360°

Range Ø H 2.50m/T=18°C: seated 4.00m / tangential

10m / radial 6m

2 - 3m

Recommended height for mounting

Light measurement:

• **One channel to switch the lighting**

Type of contact: NOC/with pretravel tungsten

contact

Contact load: 2300W cos φ=1 /

1150VA cos φ=0.5

5 min. - 30 min. / test

Time-settings:

• **Channel 2 for control devices (only reacts on motion)**

Contact load: 230V~, 3 A cos φ=1, µ-Contact

5min. - 120min. with time delay

of 5min. for follow-up time >

15min./

Alarm impulse

Dimensions H x Ø [mm]

PD9-M-1C+HVAC: Ø 45 x H 28 mm

Power supply L165 x W 24 x H 24 mm

Technical data PD-Slave

Power supply: 230V ~ ±10 %

Impulse output: Optocoupler max. 2W

Impulse duration: 2 sec. or 9 sec.

Dimensions: see above

CE Declaration of Conformity: The product complies with the low voltage recommendation 2006/95/EC and the EMV recommendation 2004/108/EC.