















Code	92732	92732	92732	92732
	 Sicherheitshinweise	 Safety instructions	 Consignes de sécurité	 Veiligheidsinstructies
	Arbeiten an elektrischen Anlagen dürfen nur von Elektrofachkräften oder von unterwiesenen Personen unter Leitung und Aufsicht einer Elektrofachkraft entsprechend den elektrotechnischen Regeln vorgenommen werden.	Work on the mains supply may only be carried out by qualified professionals or by instructed persons under the direction and supervision of qualified skilled electrical personnel in accordance with electrotechnical regulations.	Travailler sur un réseau ne s'improvise pas, seul un electricien qualifié et habilité doit effectuer ce raccordement.	Werkzaamheden aan elektrische installaties mogen alleen door gekwalificeerde installateurs of geschoold personeel uitgevoerd worden en dit in overeenstemming met de elektrotechnische voorschriften.
	Vor Montage Leitung spannungsfrei schalten! Dieses Gerät ist nicht zum Freischalten geeignet.	Disconnect supply before installing! This device is not to be used to isolate other equipment from the mains supply.	Avant de commencer l'installation, assurez-vous que l'alimentation est coupée. Cet appareil ne doit pas être utilisé pour isoler d'autres appareils de l'alimentation secteur.	Netspanning uitschakelen alvorens te beginnen met de montage. Dit toestel mag niet gebruikt worden om de aangesloten apparaten te isoleren van de voedingspanning.
	DALI ist nicht SELV – Es gelten die Installationsvorschriften für Niederspannung. Die DALI-Schraubklemmen dürfen nicht an 230 VAC angeschlossen werden!	DALI is not SELV – the installation instructions for low voltage apply. The DALI screw clamps must not be connected to 230 VAC!	DALI est différent de SELV – Les prescriptions d'installation pour basse tension doivent être respectées. Les bornes DALI ne doivent pas être raccordées à 230 VCA!	DALI is niet SELV – De voorschriften voor laagspanningsinstallaties zijn van toepassing. De DALI-schroefklemmen mogen niet op 230 VAC worden aangesloten!
	Lesen Sie dieses Beiblatt und die Betriebsanleitung vor der Inbetriebnahme des Gerätes. Die Kenntnis dieser Dokumente gehört zur bestimmungsgemäßen Verwendung!	Read this supplementary sheet and the operating instructions before putting the device into operation. Knowledge of these documents is part of the intended use!	Avant la mise en service de l'appareil, veuillez lire cette fiche complémentaire et le mode d'emploi de l'appareil. La connaissance de ces documents fait partie d'une utilisation conforme !	Lees dit aanvullende blad en de gebruiksaanwijzing voordat u het apparaat in gebruik neemt. Kennis van deze documenten maakt deel uit van het beoogde gebruik!
	<b>Funktion</b>	<b>Function</b>	<b>Fonctionnement</b>	<b>Functie</b>
	DALI-Tastermodul mit 4 binären Eingängen und integriertem BLE-Gateway zur versteckten Montage hinter UP-Einsätzen.	DALI pushbutton module with 4 binary inputs and integrated BLE gateway for hidden mounting behind flush mount switches.	Module bouton-poussoir DALI avec 4 entrées binaires et passerelle BLE intégrée pour montage caché derrière un interrupteur encastré.	DALI drukknopmodule met 4 binaire ingangen en geïntegreerde BLE gateway voor verborgen montage achter inbouwchakelaars.
	Das Gerät wird über den DALI-Bus mit Spannung versorgt. Die Parametrierung der DALI-LINK-Lösung erfolgt über Bluetooth mit einem Smartphone und der B.E.G. DALI-LINK App. In der Werkseinstellung schaltet jeder Eingang mittels eines kurzen Schließ-impulses das Licht im Broadcast-Verfahren an und aus. Voller Funktionsumfang ist mit Zubehör aktivierbar. Langes Drücken >10 Sekunden auf den Resetknopf bewirkt ein Reset des Passworts (Werkseinstellung: 123456).	The device is supplied with operating voltage via the DALI bus. DALI-LINK can be parameterised via Bluetooth using a smartphone and the B.E.G. DALI-LINK app. In factory mode, each input switches the light in broadcast on and off by means of a short closing impulse. The complete functional range can be activated using accessory. A long press >10 seconds on the reset button resets the password (factory setting: 123456).	L'appareil est alimenté uniquement par le bus DALI. Le paramétrage de la solution DALI-LINK est effectué via Bluetooth en utilisant un smartphone et l'appli B.E.G. DALI-LINK. Dans la configuration d'usine, chaque entrée allume et éteint la lumière en mode broadcast par une brève impulsion de fermeture. Toutes les fonctions peuvent être activées à l'aide d'accessoires. En appuyant le bouton « Reset » pour plus de 10 secondes, le mot de passe est réinitialisé (réglage d'usine : 123456).	Het toestel wordt alleen door de DALI bus van spanning voorzien. DALI-LINK kan worden geparametriseerd via Bluetooth met een smartphone en de B.E.G. DALI-LINK app. Met de fabrieksinstelling schakelt elke ingang het licht in broadcast aan en uit door een korte sluitimpuls. Volledige functionaliteit kan worden geactiveerd met accessoires. Door >10s op de „reset“ knop te drukken, wordt het paswoord gereset (fabrieksinstelling: 123456).



92732	<b>DE</b> Installation B.E.G. Remote Control App (B.E.G. One)	<b>UK</b> Installation B.E.G. Remote Control App (B.E.G. One)	<b>FR</b> Installation B.E.G. Remote Control App (B.E.G. One)	<b>NL</b> Installatie van de B.E.G. Remote Control-app (B.E.G. One)
  	Installieren Sie die aktuelle Version der B.E.G. One App auf ihrem iOS-, oder Android-Smartphone.	Install the latest version of the B.E.G. One app on your iOS or Android smartphone.	Installez la dernière version de l'application B.E.G. One sur votre smartphone iOS ou Android.	Installeer de actuele versie van de B.E.G. One app op uw smartphone met iOS of Android.
	Montage	Mounting	Montage	Montage

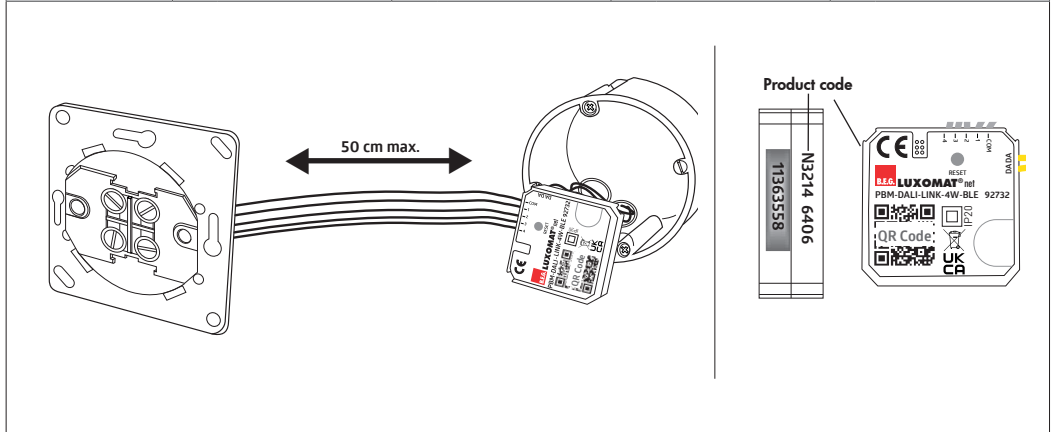

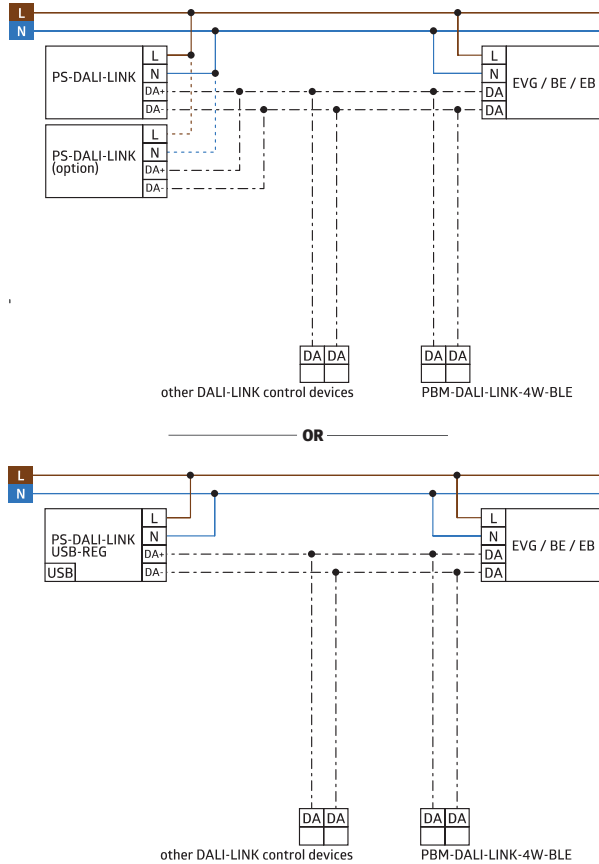
	<b>EU-Konformitätserklärung</b> Das Produkt erfüllt die Richtlinien über 1. die elektromagnetische Verträglichkeit (2014/30/EU) 2. die Niederspannung (2014/35/EU) 3. die Beschränkung der Verwendung bestimmter gefährlicher Stoffe in Elektro- und Elektronikgeräten (2011/65/EU) und (2015/863/EU)	<b>EU Declaration of conformity</b> This product respects the directives concerning 1. Electrical Equipment Safety Regulation 2016 2. Electromagnetic Compatibility Regulation 2016 3. The Restriction of the Use of Certain Hazardous Substances in Electrical and Electronic Equipment Regulation 2012 <b>Contact</b> BEG (UK) Ltd., Apex Court – Grove House - Camphill Road - West Byfleet, Surrey KT14 6SQ	<b>Déclaration de conformité UE</b> Ce produit répond aux directives sur 1. la compatibilité électromagnétique (2014/30/UE) 2. la basse tension (2014/35/UE) 3. la restriction de l'utilisation de certaines substances dangereuses dans les appareils électriques et électroniques (2011/65/UE) et (2015/863/UE)	<b>EU-conformiteitsverklaring</b> Dit product beantwoordt aan de volgende richtlijnen 1. Elektromagnetische compatibiliteit (2014/30/EU) 2. Laagspanning (2014/35/EU) 3. Verbod op gebruik van gevaarlijke chemicaliën in elektrische en elektronische apparatuur (2011/65/EU) en (2015/863/EU)
---	---	---	---	---



	Technische Daten	Technical data	Caractéristiques techniques	Technische gegevens
<b>Bluetooth</b>	Funksystem	Radio system	Système radio	Radiosysteem
<b>2.40 – 2.48 GHz</b>	Sendefrequenz	Transmission frequency	Fréquence de transmission	Zendfrequentie
<b>3 dBm</b>	Sendeleistung	Transmitting power	Puissance d'émission	Zendvermogen
<b>DALI-Bus max 22.5 V ~</b>	Spannung	Voltage	Tension	Spanning
<b>7 mA</b>	Stromaufnahme	Power input	Absorption de courant	Stroomopname
<b>II / IP20</b>	Schutzklasse / Schutzart	Class / Degree of protection	Classe / Type de Protection	Klasse / Beschermingsgraad
<b>38 x 38 x 12 mm</b>	Abmessungen	Dimensions	Dimensions	Afmetingen
<b>max. 50 cm</b>	Kabellänge	Cable length	Longueur de cable	Kabellengte
<b>-25°C – +50°C</b>	Umgebungstemperatur	Ambient temperature	Température ambiante	Omgevingstemperatuur
<b>1 min</b>	Nachlaufzeit (nur im Treppenhausmodus)	Follow-up time (only in staircase mode)	Durée de temporisation (seulement en mode cage d'escalier)	Nalooptijd (alleen in trappenhuismodus)
<b>PC</b>	Gehäuse	Housing	Boîtier	Behuizing

92732	<b>DE</b> Fehlersuche	<b>UK</b> Trouble shooting	<b>FR</b> Dépannages	<b>NL</b> Probleemoplossing
	<p><b>1. Zu hoher Stromverbrauch an DALI-Linie</b></p> <p>Berücksichtigen Sie bitte bei Ihrem System die Gesamtstromaufnahme aller DALI-Einheiten.</p>	<p><b>1. Power consumption on DALI line too high</b></p> <p>Please be aware of the total power consumption of all the DALI units in your system.</p>	<p><b>1. Surc consommation sur la ligne DALI</b></p> <p>Vérifier la consommation totale de l'ensemble de vos produits DALI.</p>	<p><b>1. Hoog verbruik op DALI bus</b></p> <p>Hou aub rekening met de totale stroomopname van alle DALI toestellen in uw systeem.</p>
	<p>Produktseite im Internet</p>	<p>Product page on the internet</p>	<p>Page produit sur notre site internet</p>	<p>Productpagina op het internet</p>