



**B.E.G.**

# LUXOMAT® PICO-M-1C-FC-(S-FC)

B.E.G. - PICO-M-1C-FC



LUXOMAT

PICO-M-1C-FC

Hardware configuration and operation

Position LED's

Settings carried out using remote control (optional)

LUXOMAT® IR-PD-1C Remote Control

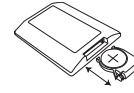

**Check Battery:**  
Open battery compartment by pressing the plastic springs together and removing the battery-holder.

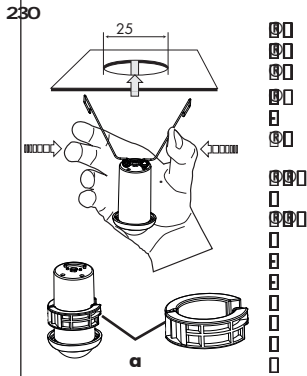

LED 1 green  
LED 2 red  
LED 3 white

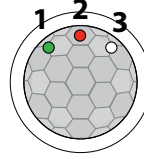

**Self test cycle**  
After an initial 60-second self-test cycle, the LUXOMAT® PICO-M-1C-FC is ready for operation. (see LED function displays see point 19). After that the factory setting is active (see point 12).

861189011  
862453581130291  
86243029116311  
1122111122431311

00008FNPUEDPOUSPM901

Key functions in closed state

- Permanent protection against sabotage**  
This function blocks the unit permanently. This operating mode can only be activated during the period of 5 seconds (white LED flash) after pressing the "Lock" button. The procedure for leaving this mode is as follows:
  1. Switch off the current
  2. Apply current for 31 - 59 seconds
  3. Switch of the current again
  4. Apply current, wait for selftest cycle
  5. Open detector

**Light ON/OFF during the detection of motion plus follow-up time; Activation of the 12 h-ON/OFF-function by holding down the push button**

**Activation/Deactivation of the test function**

**Switches channel off and is immediately active again, exits all timers, interruption of light measurement**

**Confirmation**

**Changes to "open" state**

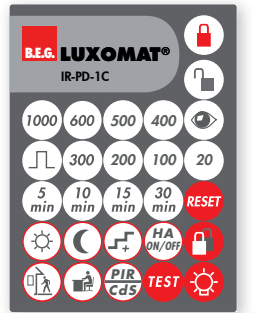

**Wall bracket for remote control IR-PD-1C**

An adhesive film for the surface of the IR-PD-1C is included with the device. If required, this can be used for any B.E.G. remote control with 27 keys.

Settings by remote control

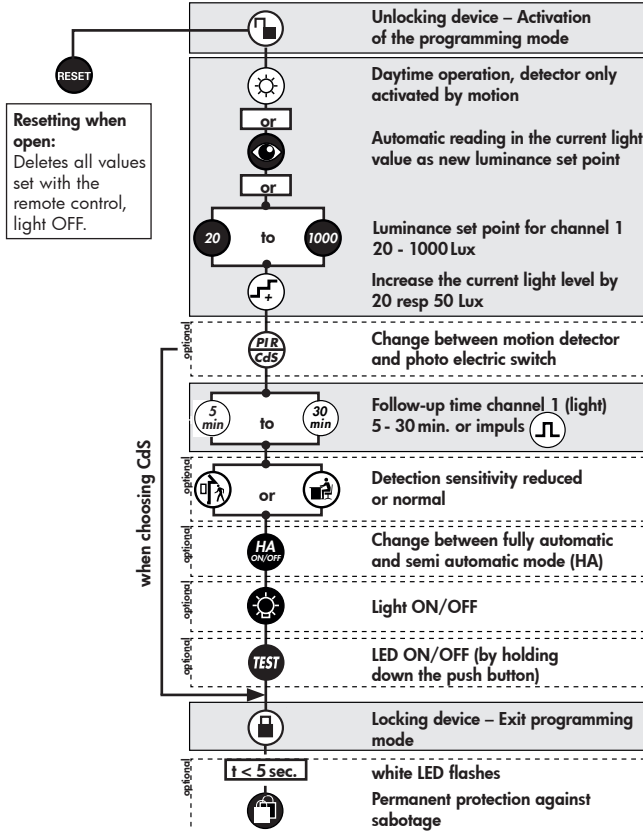

**Resetting when open:**  
Deletes all values set with the remote control, light OFF.

when choosing Cds

**8. Explanation of the remote control button functions**

**8a. In the initialisation period**

- 12 h Light ON/OFF (party function)**  
Activated by "Light" - push button
- Deactivated by "Reset" - push button (default)

- Corridor function (see point 10a)**  
Activated by "outside" - push button
- Deactivate by "inside" - push button (default)

- Forced shutdown (see point 10c)**  
Activated by "sun" - push button
- Deactivate by "moon" - push button (default)

**8b. In opened state**

- This push button opens the detector and the following functions can then be programmed.  
**Attention:** The detector is closed automatically:
  - after every voltage recovery
  - after 3 minutes

- The state changes to "closed".  
In the first 5 seconds, the white LED flashes every 0.5 seconds. During this time, sabotage protection can be activated.

The device distinguishes between 2 procedures:  
 • **Reading in with lighting switched on:**  
The switch-on value is determined automatically.

- Determining the switch-on value:
1. Press the "eye" push button
  2. Switch off the light (2 seconds later)
  3. Read in the brightness
  4. Switch-on value = Read brightness

• **Reading in with lighting switched off:**  
When the push button is pressed, the current brightness is specified as the switch-on value. The switch-off value is determined automatically.

**20** **1000**  
If the brightness has been modified, the switch-off threshold is recalculated.

Each time the push button is pressed, the device increases the current switch-on value in increments of 20 Lux for a current switch-on value of < 100 Lux and in increments of 50 Lux for a current switch-on value of > 100 Lux.

- Standard sensitivity for most applications
- Reduced sensitivity for outdoor applications

When the pulse function is active, a pulse of 1 sec. is generated every 9 sec. If the pulse function is activated via remote control, the pause between 2 pulses can be modified. After activating the function via the "Pulse" push button, select the desired time within 5 sec.:

$$\left( \frac{5}{min} \right) = 9 \text{ sec.}, \left( \frac{10}{min} \right) = 10 \text{ sec.}, \left( \frac{15}{min} \right) = 15 \text{ sec.}, \left( \frac{30}{min} \right) = 30 \text{ sec.}$$

The "Test" push button can be used to set the LED ON/OFF function. To do this, hold down the push button for 3 sec. **Please note** that in the open state and in test mode, the LED indicators are always ON.

**Twilight switch function (CdS)**  
If the CdS function is active, the detector acts as a simple twilight switch. Only the brightness can be set in this mode. Movements are no longer indicated by the red LED.

**Push button acknowledgement:**  
Each push of a button is indicated by lamp acknowledgement and by the white LED.  
"Light ON" status: OFF/ON (approx. 0.5 sec. each)  
"Light OFF" status: ON/OFF (approx. 0.5 sec. each)

## 9. Switch-off threshold brightness

- If the switch-on threshold has been modified by the potentiometer or remote control, the switch-off threshold stored in the EEPROM is deleted and is then recalculated on the next activation.

Determining the switch-off value

- Switch on for 5 min. with dark and motion
- Light OFF for 2 sec.
- Internal calculation of the switch-off value

- If the eye push button is pressed, the switch-off threshold is recalculated. See also Remote control → Eye section

- Switch-off delay

If the determined switch-off threshold is exceeded during operation, the detector only switches off after a delay of approx. 15 minutes. This compensates for any brief fluctuations in the brightness.

## 10a. Behaviour of external push button/IR "Light"

The "Corridor" and "Light ON/OFF" functions are mutually exclusive. If both are activated, the detector performs the corridor function.

The behaviour when the push button is pressed is defined as follows:

### Corridor function activated

#### Light ON:

Push button pressed briefly: Light OFF → Active after 5 sec.  
Push button held down: Light OFF → Active after 5 sec.

#### Light OFF:

Push button pressed briefly: Light ON as long as motion + Lag time  
Push button held down: Light ON as long as motion + Lag time

## 10b. Behaviour of external push button/IR "Light"

### 12 h Light ON/OFF activated

#### Light ON:

Push button pressed briefly: Light OFF → Active after 5 sec.  
Push button held down: 12 h OFF

#### Light OFF:

Push button pressed briefly: Light ON as long as motion + Lag time  
Push button held down: 12 h ON

### 12 h Light ON/OFF deactivated

#### Light ON:

Push button pressed briefly: Light OFF as long as motion + Lag time  
Push button held down: Light OFF as long as motion + Lag time

#### Light OFF:

Push button pressed briefly: Light ON as long as motion + Lag time  
Push button held down: Light ON as long as motion + Lag time

## 10c. Behaviour of external push button/IR "Forced shutdown"

### Forced shutdown active

#### Light OFF:

Push button pressed briefly: Push button pressed briefly: Light ON for approx. 30 min., then forced shutdown if the set brightness is still exceeded.

## 11. Other functions

### Activation of light for 12 h via mains interruption

- Interrupt current
- Apply current for 2 to 5 sec.
- Interrupt current again
- Apply current
- Detector is now ON for 12 h

### Exiting sabotage

- Interrupt current
- Apply current for 30 to 60 sec.
- Interrupt current again
- Apply current
- Detector is in simple closed state

### 230V AC for 1 - 3 sec. at push button connection R

If 230V AC is applied for 1 - 3 sec. at push button connection S, this is interpreted as a slave signal at slave connection R. This ensures that the detector is compatible with previous versions.

## 12. Reset and default settings

### 1. Default settings

If the detector is not programmed, the factory setting is activated: 500Lux and 10 min.

### 2. Reset

After a reset in open state, all factory settings are activated.



## 13. Fully automatic and semi automatic mode

(see functions IR-PD-M-1C)



### Fully automatic operation

In this operating mode, the lighting switches automatically on and off for increased comfort, depending on presence and brightness.  
- Channel 1 switches on in the event of motion if "dark" is detected.

### Semi automatic operation

In this operating condition, in order to gain increased savings, the lighting is energized only after being manually switched on.

Switch-off takes place automatically or manually.

The semi automatic mode basically behaves like the fully automatic one. However, the difference is that switching-on must always be carried out manually!

As many (NO-contact) buttons as desired can be wired in parallel on the "R" button input (ON/OFF).

**Triggering in semi automatic mode:** If the detector switches off in semi automatic mode (lag timer elapsed), the detector can be switched on again within 10 sec. by motion (despite semi-automatic mode).

## 14. Range of Coverage

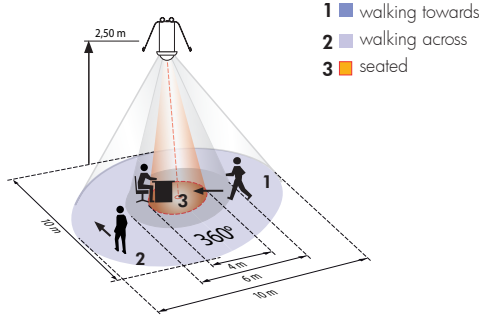

- walking towards
- walking across
- seated

## 15. Exclude sources of interferences

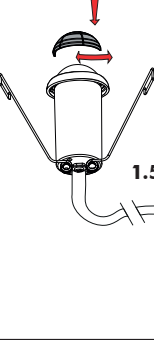

In case the sensing area of the LUXOMAT® PICO-M-1C-FC or PICO-S-FC is too large or areas are being covered that should not be monitored, the range can be reduced or limited through use of the enclosed masking clips.

1.5 m

Master

Slave

L L' N R

L N R

L = Brown  
L' = Black  
N = Blue  
R = Grey

L = Brown  
N = Blue  
R = Grey

## 16. Technical data PICO-M-1C

Sensor and power supply in one case, cable length 1,5 m

**Power supply:** 230V ~ ±10%

**Power consumption:** < 0,35 W

**Ambient temperature:** -25°C – +50°C

**Degree of protection/class:** IP65 / II

**Settings:** by remote control

**Light values:** 20 - 1000Lux

**Extension of the detection area:** with Slaves

**Area of coverage:** circular 360°

**Range Ø H 2.50m/T=18°C:**

seated 4.00m / tangential 10m / radial 6m

**Recommended height for mounting:** 2 - 3 m

**Light measurement:** daylight and artificial light

**• One channel to switch the lighting**

**Type of contact:** NOC

**Contact load:** 2300 W cos φ=1 / 1150 VA cos φ=0,5, μ-contact

**Time-settings:**

5 min. - 30 min. / Test with remote control

**Dimensions:**

**Visible part when built into ceiling:** H 15 x Ø 33 mm

## Technical data PICO-S

**Power supply:** 230V ~ ±10%

**Impulse output:** Optocoupler max. 2 W

**Impulse duration:** 9 sec.

**Dimensions:** see above

CE Declaration of Conformity: The product complies with the low voltage recommendation 2006/95/EC and the EMV recommendation 2004/108/EC.

## 17. Wiring diagram

Standard mode master 1-channel occupancy detectors with R terminal

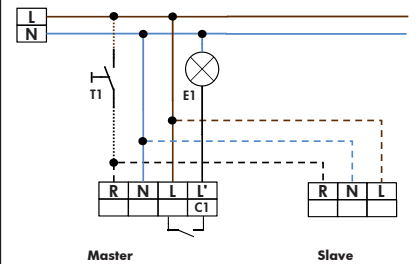

**optional:** T1 = NO - Push button for semi automatic; Extension of the detection area with Slave-devices

## 18. LED function displays

LED function indicators after each mains recovery (60 sec. initialisation period)			
Operating state	LED function indicators		
Factory program active	White, red and green flash in quick succession for 10 sec., then initialisation indicators, see below		
Double-locked	White and green shines for 5 sec. all 20 sec., afterwards initialising notification		
	Indicator unprogrammed	Indicator programmed	Indicator also when forced shutdown is activated
Standard mode	Red flashes	Red flashes quickly	Every 5 sec., 4x white, red and green in quick succession
12 h ON/OFF active	Red and green flash	Red and green flash quickly	Every 5 sec., 4x white, red and green in quick succession
Corridor active	Red and white flash	Red and white flash quickly	Every 5 sec., 4x white, red and green in quick succession
12 h ON/OFF & corridor active	Red, green and white flash	Red, green and white flash quickly	Every 5 sec., 4x white, red and green in quick succession
CdS active	-	Red and white flash	Then no red LED for motion detection

LED function indicators during operation	
Process	LED function indicators
Motion detection	Red flashes on each detected movement
Semi automatic mode active	White is ON
Corridor active	White ON 1 sec. and OFF 4 sec.
Corridor and semi automatic mode active	White ON 4 sec. and OFF 1 sec.
Too bright detected	Green flashes
Light measurement active	Green flashes once every 10 sec.
12 h ON/OFF function active	Red and green flash alternately
IR command	White flashes once
IR command "Open" and sabotage active	White and green flash once slowly

## 19. Article / Part nr. / Accessory

Type	FC
PICO-M-1C (Master)	92712
PICO-S (Slave)	92700

LUXOMAT® Remote control:

IR-PD-1C (incl. wall bracket) 92520  
IR-PD-Mini 92159