

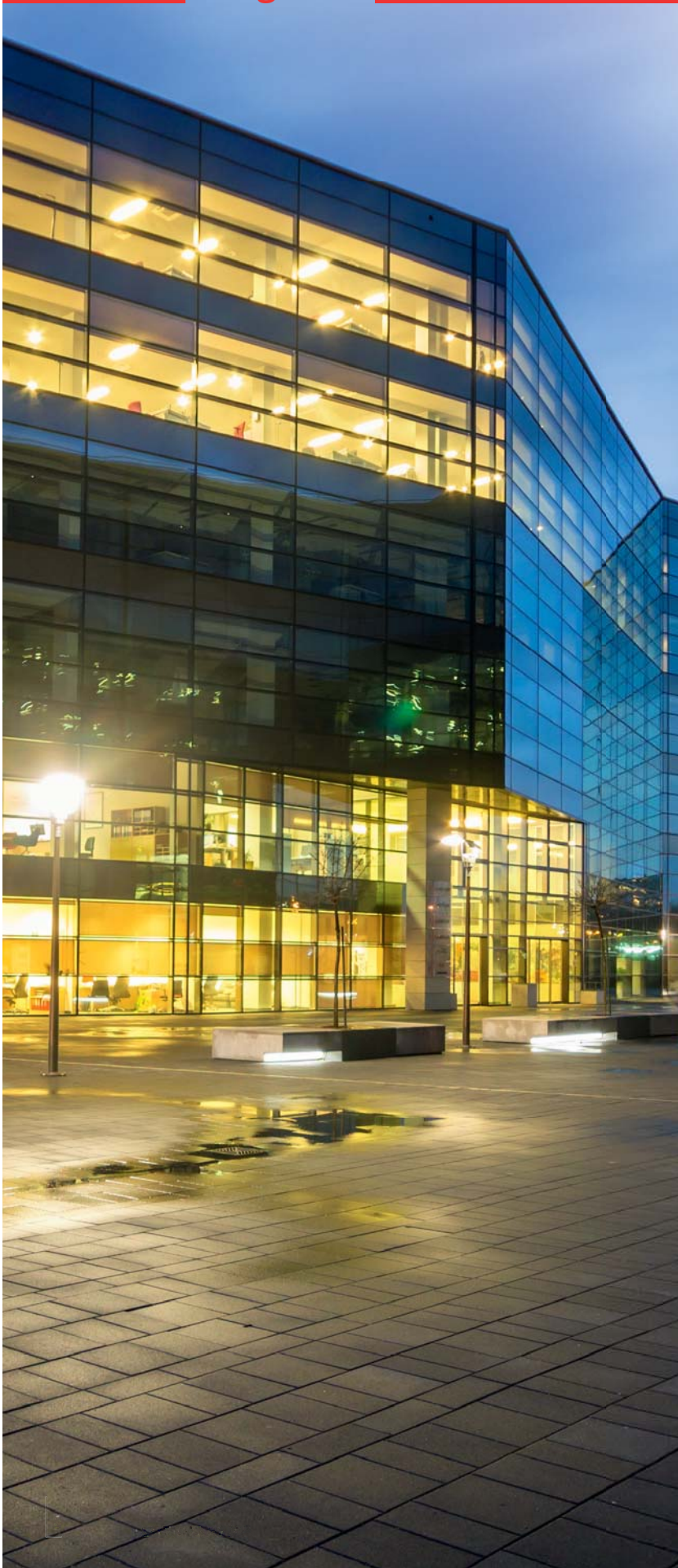

























## Automatic lights catalogue



## Legend



	LED light
	Colour reproduction
	Voltage
	Typ. power input
	Degree of protection class
	Impact protection
	Ambient temperature
	Housing
	Dimensions
	Photobiological safety
	Anti-glare
	Detection area
	Radar / HF technology
	Range
	Switch-on threshold
	Follow-up time
	Remote control-capable
	Micro USB
	E27 fitting
	Switching power
	Recommended mounting height
	Orientation light
	Flammability rating

**Introduction**

Company / LED technology/ motion detectors / HCL.....	4
Applications for lights.....	13

**Biodynamic light****Recessed luminaires for modular ceilings**

PL1-LED-TW	panel lights module 625.....	18
PL1-LED-TW	panel lights module 600.....	19
PL1-LED-TW	panel lights module 312,5 x 1250 mm.....	20
PL1-LED-TW	panel lights module 300 x 1200 mm.....	21

**Pendants**

PL2-LED-TW	panel lights 300 x 1200 mm.....	22
Accessory.....		23

**LED indoor lights with or without microwave detector****Surface-mounted luminaires**

AL22-LED-HF	radio-crosslinkable (HF) radar round light.....	27
L8-LED-HF	(HF) radar round light d=300 mm.....	28
L9-LED-HF	(HF) radar round light d=475 mm.....	29
AL8-LED-HF	Flat (HF) radar round light.....	30
AL8-LED-3C	Flat round light with three light colours (BE).....	31
AL8-LED-3C-HF	Flat (HF) radar round light with three light colours.....	32
AL12-LED-3C	Flat square luminaire with three light colours.....	33
AL12-LED-3C-HF	Flat (HF-)square luminaire with three light colours.....	34
HF-L7/-L8	(HF) radar round light d=300 mm E27-socket.....	35
HF-L11	(HF) radar round light d=475 mm E27-socket.....	36
HF-L1 Glass	(HF) radar round light d=275 mm E27-socket.....	37

**LED downlights**

DL10-LED-3C	Downlight diffusor with three light colours.....	40
DL11-LED-3C	Downlight reflector with three light colours.....	41
DL12-LED-3C	Downlight UGR<19 with three light colours.....	42

**Occupancy detector with LED orientation light**

PD2N-LED	Occupancy detector with LED light.....	44
----------	--	----

**LED outdoor lights**

FL2N-LED	LED floodlight 26 W with motion detector.....	46
FL3N-LED	LED floodlight 14 W with motion detector.....	47
ALC-B/-K	System light with motion detector.....	48
SG globes	System globes.....	49
AL1	Wall light with motion detector.....	50

**LED moisture-proof lights**

AL60-LED-PD9M	Moisture-proof light with occupancy detector.....	52
AL60-LED-HF	Moisture-proof light with microwave occupancy detector.....	53

Remote controls.....	55
----------------------	----

Product listing.....	57
----------------------	----



### 1975

The foundation stone of our comprehensive range was the development and production of emergency lights. Shortly afterwards came the production of complete systems for emergency lighting installations. While B.E.G. still has emergency lighting in its range today, this of course comes with state of the art technology and energy-saving LEDs.

### Energy-efficient products combined with tradition

Founded in 1975, family-owned B.E.G., headquartered in Lindlar, Germany, has stood for quality and innovation for over 40 years. From the very beginning, our team's focus has been on satisfying customers. The B.E.G. product range is divided into six product lines: LUXOMAT®, LUXOMATIC®, LUXOMAT®net, SAFETYLUX®, CHRONOLUX® and B.E.G. SMARTHOME®. B.E.G. offers customers a wide product range, individual solutions, outstanding quality and personal service.

### 1986

B.E.G. was one of the first companies in Germany to produce motion detectors and automatic lighting. Since then, B.E.G. has produced many generations of motion detectors, which are installed primarily outside buildings, in particular for security.

The rapid growth in building automation and the resultant rise in demand for intelligent control products has led to the continual expansion of the daylight-dependent/occupancy-dependent detection business. The installation of occupancy detectors is being driven not only by convenience, but also now by cost reduction through energy saving, and environmental protection.



## Company history



**2007**

On a terrain of almost 4 ha, the current European distribution and logistics centre with adjoining production and development facilities started operation in Lindlar.

4 years later, the logistics centre was extended by several thousand m<sup>2</sup> to meet the increasing demand.

**2017**

The former administration building becomes a research and development centre with light laboratory. For some time now, B.E.G. has its focus on networked products (e.g. DALI, LON, KNX). Thanks to the new development centre, B.E.G. is able to react to demands on the market within a short time.

B.E.G. has an ever increasing number of branches and agencies in many countries of the world. Each branch or agency employs well-trained personnel offering the best support possible in all issues with respect to building automation.

**2014**

The new administration building was built next door to the production and distribution centre. The new building is equipped with modern KNX bus technology and B.E.G.'s own KNX products, which provide for an important cost reduction of the operating costs. These products are also used in a research project of TH Köln (University of Applied Sciences).



## B.E.G. detector lights with LED technology

### LED Technology

- LED technology is the lighting of the future: This innovative light source is a technically-advanced, economical and exceedingly environmentally-friendly alternative to conventional lighting technology.
- Good quality LEDs are very economical in terms of electricity consumption and have an extremely long life. B.E.G. combines reliable electronics with high quality LED technology. An in-house developed innovative thermal management system prevents overheating of the LEDs and the electronics, thus ensuring a long lifespan.
- LED lights with integrated B.E.G. sensor technology are the most economical solution for your customers. We have fitted our lights and floodlights with motion detectors or microwave detectors for a variety of applications. These are used to activate the lighting only when motion is detected and there is too little daylight. This technology therefore further increases the energy efficiency of the lights.

### HF detector technology

- B.E.G. high-frequency microwave motion detectors send and receive radar waves at a frequency of 5.8 GHz.
- Based on the Doppler effect, frequency changes in the waves reflected from a moving object are measured and thus movement is detected. The detection area also depends on the size and speed of the moving object.
- Radar waves can penetrate walls. Therefore clear delineation of a room with microwave technology is only partially possible. We therefore recommend that you check its applicability for your intended use.
- The B.E.G. detector technology used also offers safe and convenient installation. Detectors can be quickly and easily adjusted to on-site requirements. Parameters such as range, switch-on threshold and follow-up time can be controlled via potentiometers.
- Intelligent light switching can make a great contribution to reducing energy consumption. The light is only switched on if it is needed.

### Motion detector technology

- Luminaires and spotlights with high-performance motion detectors are optimised for time-efficient and simple fitting. Detectors are individually adjustable for optimum setup of the detection area, so that for example the street is not covered when installation is on the outside of a property.
- Motion detectors are designed to reliably detect moving sources of heat in their detection area. According to the current ambient light level, they automatically switch the light on when movement is detected. If movement is no longer detected, the detector switches the light off again after the follow-up time previously configured.
- This is made possible by Passive Infrared (PIR) technology: The detection area of the motion detector is divided into many small sub-areas. The detector measures heat radiation in these sub-areas, e.g. the heat given off by a living being. If temperature differences occur in several sub-areas due to movement, these are recognised by the PIR sensor built into the motion detector. The sensor itself does not emit any infrared and is therefore described as passive.
- If requirements should change, settings can be adjusted according to needs. Instead of the potentiometers, it is even easier to adjust the settings using a suitable B.E.G. remote control.
- B.E.G. stands for decades of experience in developing motion detectors and automatic luminaires, and for high levels of quality and reliability. This means B.E.G. lights and spotlights with motion detection technology provide the perfect combination of security, convenience and energy saving.

### Bidynamic occupancy detector technology (HCL)

- The PD4-M-HCL bidirectional occupancy detector with integrated DALI controller and "Tunable White" function for "Human Centric Lighting" regulates different lighting groups according to occupancy and daylight levels, and also has daylight-dependent control of brightness and colour temperature using a real-time clock.





In 2002, scientists discovered a third kind of photoreceptor in the retina of the eye. These are not primarily for vision, but are very sensitive to light with a high level of blue in it. Among other things, they regulate the production of hormones that are essential for the human "body clock". This new discovery made sense of many things: for thousands of years, daylight has synchronised the biorhythms of people living predominantly outdoors.



Without daylight, the biorhythms get out of step. Modern humans mostly live in rooms which are not always flooded with sufficient daylight and are generally lit artificially. Therefore, for many hours in the day, daylight's influence on biorhythms is missing, which can have negative effects on our well-being, concentration and health.



HCL lighting, or "Human Centric Lighting", is lighting with humans as its focus. Therefore, lighting must take account of the latest discoveries and not only provide good static light, but also consider biodynamics, in other words the right light for the right time of day.

In practice, this means trying to track daylight as closely as possible by changing the colour temperature and adjusting light output. The lights themselves must therefore be dimmable and must allow for different white tones, known as "Tunable White". Hence daylight can to a certain extent be brought into a building, even if the building's design means little or no true daylight is available. Using lighting to replicate daylight is known as "circadian lighting", from the Latin "circa" for "around" and "dies" = "day". The skill now is to define the right colour temperature and the right light level for every hour of the day. These parameters differ according to latitude, longitude and time of year. The change in lighting should take place as smoothly as possible and should not be noticeable by the user – natural daylight provides the yardstick.

Variation in the white tone can also serve other purposes, e.g. a calming atmosphere can be created by warm white tones. Using high light levels and a greater blue component in the light can produce an increase in the ability to concentrate, a so-called "light shower". There are practically no limits to creativity in this field, and different profiles for different application scenarios are listed in DIN SPEC 67600.

Many studies show that biodynamic lighting / HCL, with colour temperature and lighting levels adjusted to the current situation, generally improves well-being, productivity and health.



# Biodynamic light – the perfect solution

But since HCL usually provides, at least part of the time, a higher minimum lighting level than workplace regulations require, and thus increases the energy consumption of the lighting, the use of occupancy detectors is more important with an HCL installation, in order to save as much energy as possible. Therefore it is not enough to install dim-

mable and colour-changeable “Tunable White” lighting, but an intelligent lighting control system must be used as well, to make HCL control energy efficient.

With the PD4-M-HCL, B.E.G. offers the ideal solution.

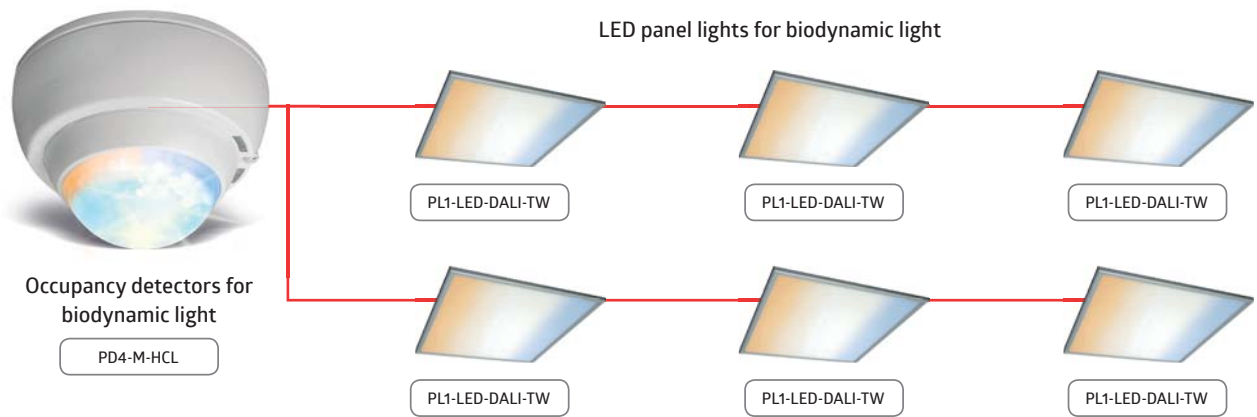

## Hospitals

As a rule, staying in hospital means that patients' movements are restricted. Depending on the condition, patients generally have to stay in bed and only rarely get to go outdoors. Not every bed provides sufficient daylight. HCL lighting can support the healing process, by stabilising patients' circadian rhythms and improving their sleep.



## Retirement homes

As the population becomes ever older, it is important that older people in retirement homes are cared for in the best way possible. With age, people's vision deteriorates, and when people stay for a long time in enclosed rooms, it is possible for their body clock to get out of sync and for residents to wake up in the night more often. HCL solutions help to reset residents' body clocks and support a better quality of sleep.



## Offices

Today, the majority of people no longer work in the open air, but in enclosed spaces. The design of the building cannot always provide sufficient daylight in all locations. Using HCL lighting, you can compensate for this deficiency and substantially enhance the workplace.



## Development and production



### EMC chamber for professional quality assurance

- In our in-house EMC laboratory, the technical team tests products for electromagnetic emission and susceptibility. B.E.G. thus ensures that products do not produce high levels of electromagnetic radiation and that emissions from other devices such as smartphones do not affect the reliability of B.E.G. products.
- In the climate chamber, the B.E.G. quality testers expose products to temperatures from -50 to +50 °C for long periods. This tests the products' temperature resistance under extreme conditions.
- Lastly, a B.E.G. quality product has to undergo impact and IP testing, in which the robustness of the case and the reliability of the seals are examined in minute detail.
- These elaborate test procedures mean that the meticulous experts at B.E.G. can ensure that their products always meet the company's highest quality requirements. On that you can rely!



### Flexibility in developing new products

- The B.E.G. CAD department uses 3D printing techniques in the production of prototypes, to develop precise and testable objects.
- Layer by layer, the three-dimensional test models are printed to match the exact specifications of computer-designed objects.



### Quality testing in in-house light lab

- LED technology is the lighting of the future: This innovative light source is a technically-advanced, economical and exceedingly environmentally-friendly alternative to conventional lighting technology.
- In our light lab, we put our luminaires and spotlights through their paces. One of the things captured by our highly sensitive measuring equipment is colour rendition. Here, our experts test against not one, but three different colour indexes. Measurement also captures colour temperature, beam angle, energy efficiency in watts per lumen and energy consumption.
- In addition, photometric information for the lights is established in our light lab. This can be used in light planning programs such as DIALUX or RELUX.

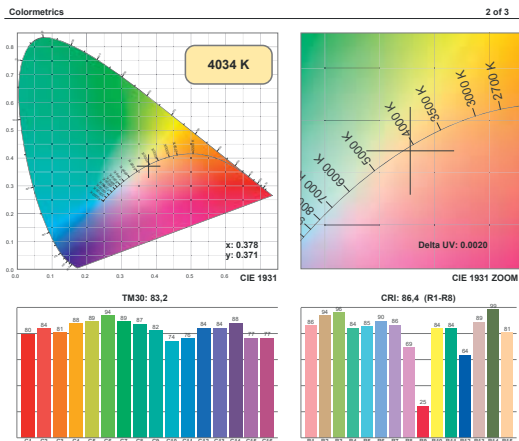
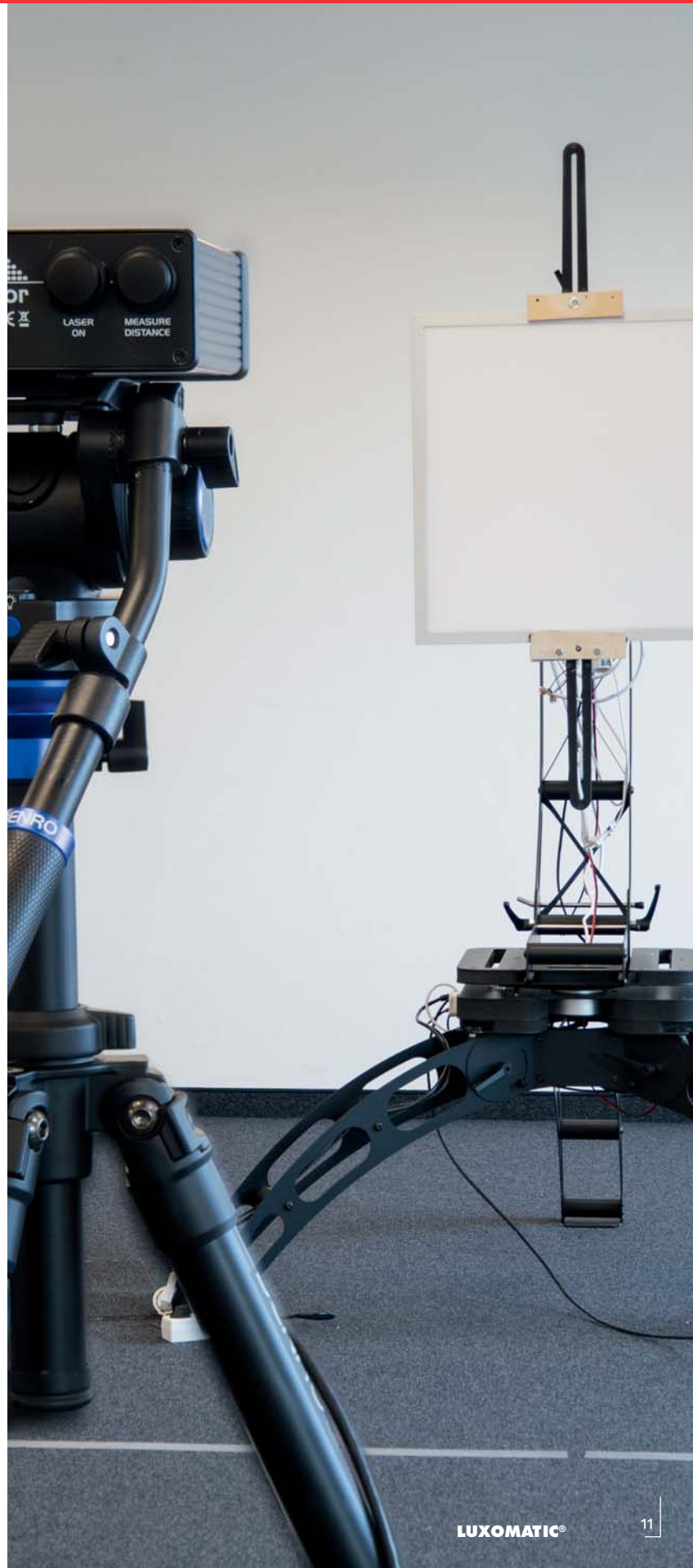

## Planner support

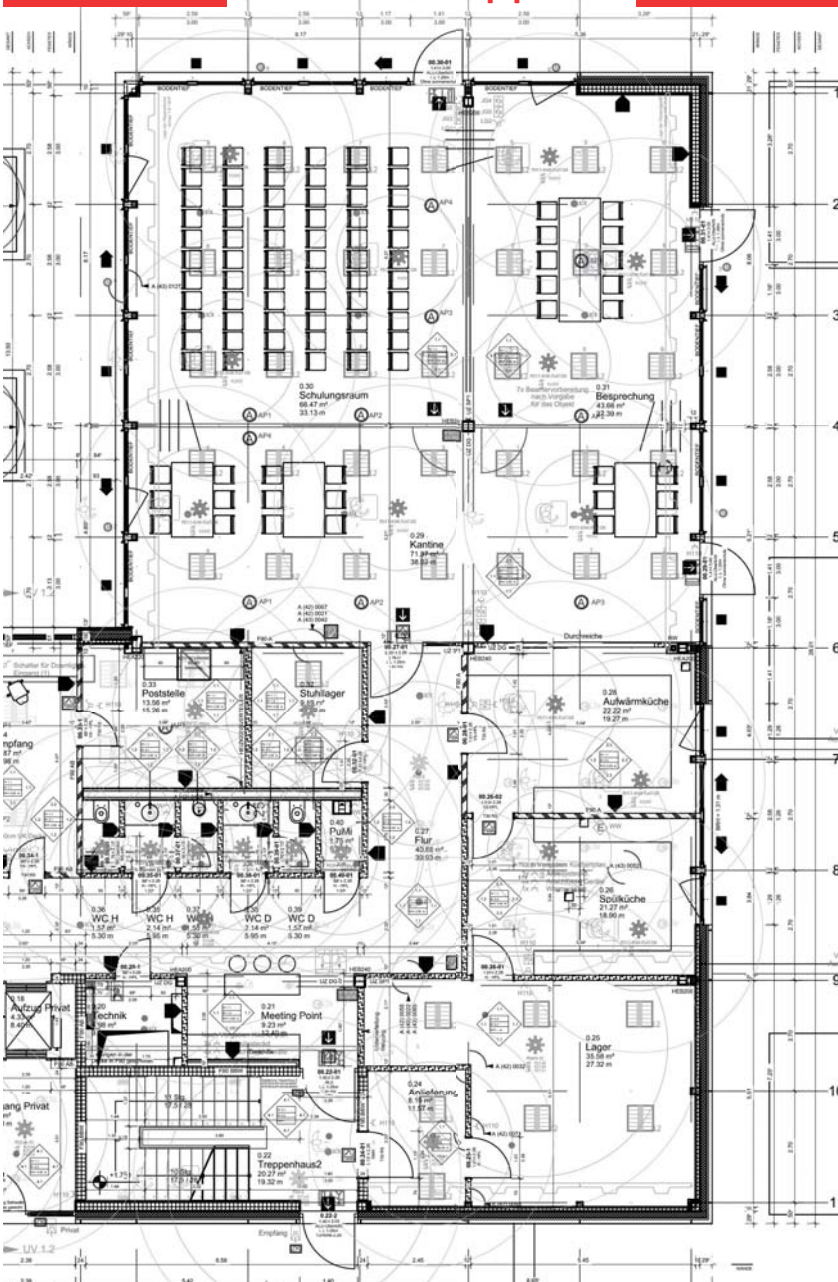

### Service and information for planners

- We provide the right solution for a wide range of requirements. If the right product is not available, then we will offer a special solution, tailor-made for your project. Our years of experience and the excellent quality of our products make us the experts in intelligent building automation.
- On our website, you can find the photometric information for all lights in LDT format for import into light planning programs such as DIALUX or RELUX.
- We support you at every stage. Our in-house planning department can produce for you, without obligation, a plan for a suitable lighting control system with specific mounting locations for motion and occupancy detectors.
- Our field operatives are all experts and undergo regular training. Therefore you will always have a capable contact at your side, even beside you on location or at the construction site.
- Our in-house staff are highly trained and will be delighted to give advice regarding your order. And your point of contact will always be happy to discuss product questions and suggest solutions.
- Our products are available exclusively through electrical wholesalers. Thanks to our long-term collaboration, wholesaler staff can in most cases help you with questions on B.E.G. products.

**General application – special, property-specific requirements must be observed.**

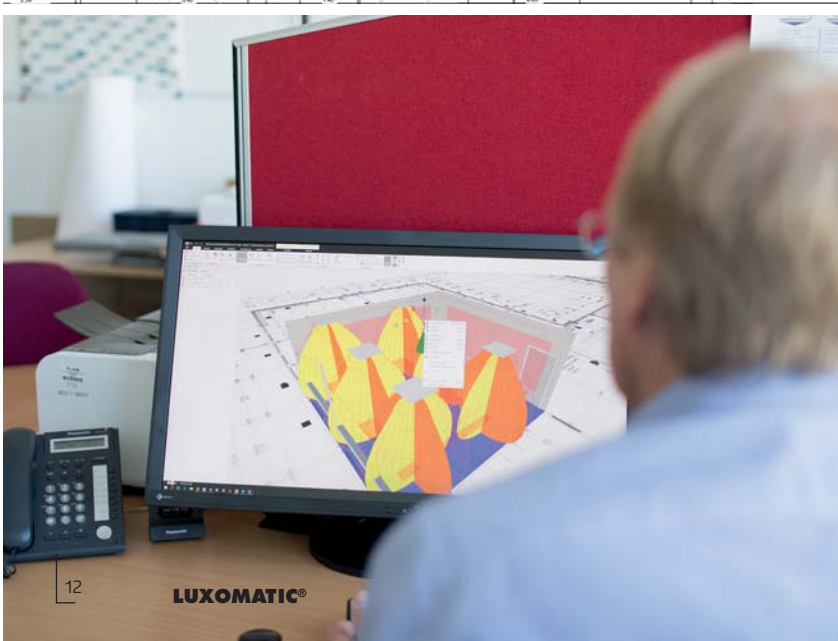

# Applications

	commercial area						social area			outdoor area				
	Offices	Meeting rooms	Corridors	Staircases	Common areas / WCs	Equipment rooms	Industry	Calsrooms	Patient rooms	Retirement home	Entrance area	Terrace / garden	Parking	Covered areas
<b>Biodynamic light</b>														
PL1-LED-TW – panel lights module 625	X	X	X					X	X	X				
PL1-LED-TW – panel lights module 600	X	X	X					X	X	X				
PL1-LED-TW – panel lights module 312,5 x 1250 mm	X	X	X					X	X	X				
PL1-LED-TW – panel lights module 300 x 1200 mm	X	X	X					X	X	X				
PL2-LED-TW – Pendant 300 x 1200 mm	X	X	X					X	X	X				
<b>LED indoor lights</b>														
AL22-LED-HF – radio-crosslinkable (HF) radar round light			X	X	X	X	X							
L8-LED-HF – (HF) radar round light d=300 mm			X	X	X	X								
L9-LED-HF – (HF) radar round light d=475 mm			X	X	X	X								
AL8-LED-HF – flat (HF) radar round light			X	X	X	X	X							
AL8-LED-3C – flat round light with three light colours			X	X	X	X	X			X	X	X	X	
AL8-LED-3C-HF – flat (HF) radar round light with three light colours			X	X	X	X	X							
AL12-LED-3C – Flat square luminaire with three light colours			X	X	X	X	X			X	X	X	X	
AL12-LED-3C-HF – flat (HF-) square luminaire with three light colours			X	X	X	X	X							
HF-L7/-L8 – (HF) radar round light d=300 mm E27-socket			X	X	X	X								
HF-L11 – (HF) radar round light d=475 mm E27-socket			X	X	X	X								
HF-L1 – (HF-) radar-glass-round light d=275 mm E27-socket			X	X	X	X								
<b>LED-Downlights</b>														
DL10-LED-3C – Downlight diffusor with three light colours			X	X	X	X		X	X					
DL11-LED-3C – Downlight reflector with three light colours			X	X	X	X		X	X					
DL12-LED-3C – Downlight UGR<19 with three light colours	X	X	X	X	X	X		X	X	X				
<b>LED outdoor lights</b>														
FL2N-LED – LED floodlight 26 W with motion detectors											X	X	X	X
FL3N-LED – LED floodlight 14 W with motion detectors											X	X	X	X
ALC-B/-C – System lights with motion detectors											X	X	X	X
AL1 – Wall light with motion detectors											X	X	X	X
<b>LED lights for moisture-proof applications</b>														
AL60-LED-PD9M – LED lights for moisture-proof application with occupancy detector					X	X	X							X
AL60-LED-HF – LED lights for moisture-proof application with (HF) microwave detector					X	X	X							X

General application – special, property-specific requirements must be observed.



## Application examples



**Biodynamic light** – commercial application – training room with PL1



**Interior lights** – commercial area – corridor with AL22









Exterior lights – exterior application – entrance area with FL2N-LED



Lights for moisture-proof applications – interior application – basement garage with AL60

## Short list

	light					technique	equipment				mounting			classification		
	LED	E27			Kelvin		PIR	DALI	3C	UGR				IP		RG0
<b>Biodynamic lights</b>																
PL1-LED-TW – panel lights module 625	X	-	45 W	3550 lm	2700-6500 K			X		X		X		20		0
PL1-LED-TW – panel lights module 600	X	-	45 W	3550 lm	2700-6500 K			X		X		X		20		0
PL1-LED-TW – panel lights module 312,5 x 1250 mm	X	-	45 W	4050 lm	2700-6500 K			X		X		X		20		0
PL1-LED-TW – panel lights module 300 x 1200 mm	X	-	45 W	4050 lm	2700-6500 K			X		X		X		20		0
PL2-LED-TW – Pendant 300 x 1200 mm	X	-	90 W	8100 lm	2700-6500 K			X		X		X		20		0
<b>LED indoor lights</b>																
AL22-LED-HF – wireless (HF) radar round light	X	-	21 W	1750 lm	4000 K	X					X			54	06	0
L8-LED-HF – (HF) radar round light d=300 mm	X	-	12 W	1000 lm	4000 K	X					X			40	02	0
L9-LED-HF – (HF) radar round light d=475 mm	X	-	24 W	2200 lm	4000 K	X					X			40	02	0
AL8-LED-HF – flat (HF-) radar round light	X	-	25 W	2100 lm	4000 K	X					X			20	08	0
AL8-LED-3C – flat round light with three light colours	X	-	25 W	2120 lm	3000/4000/5700 K				X		X			54	08	0
AL8-LED-3C-HF – flat (HF) radar round light with three light colours	X	-	25 W	2120 lm	3000/4000/5700 K	X				X	X			20	08	0
AL12-LED-3C – Flat square luminaire with three light colours	X	-	25 W	2120 lm	3000/4000/5700 K				X		X			54	08	0
AL12-LED-3C-HF – flat (HF-) square luminaire with three light colours	X	-	25 W	2120 lm	3000/4000/5700 K	X				X	X			20	08	0
HF-L7/-L8 – (HF) radar round light d=300 mm E27-socket	-	X	max. 23 W	-	-	X					X			40	06	
HF-L11 – (HF) radar round light d=475 mm E27-socket	-	X	max. 2 x 23 W	-	-	X					X			40	02	
HF-L1 – (HF-) radar globe round light d=275 mm E27-socket	-	X	max. 23 W	-	-	X					X			40	02	
<b>LED-Downlights</b>																
DL10-LED-3C – Downlight diffusor with three light colours	X	-	18 W	1950 lm	3000/4000/5700 K				X				X	40		0
DL11-LED-3C – Downlight reflector with three light colours	X	-	18 W	1950 lm	3000/4000/5700 K				X				X	40		0
DL12-LED-3C – Downlight UGR<19 with three light colours	X	-	18 W	1950 lm	3000/4000/5700 K				X	X			X	40		0
<b>LED outdoor lights</b>																
FL2N-LED – LED flood light 26 W with motion detector	X	-	26 W	2100 lm	4000 K		X				X			44	07	0
FL3N-LED – LED flood light 14 W with motion detector	X	-	14 W	1050 lm	4000 K		X				X			44	07	0
ALC-B/-K – System globes with motion detector	-	X	max. 60 W	-	-		X				X			44		
AL1 – Wall light with motion detector	-	X	max. 60 W	-	-		X				X			44		
<b>LED lights for moisture-proof applications</b>																
AL60-LED-PD9M – Lights for moisture-proof with occupancy detector	X	-	35 W	3900 lm	4000 K		X				X			65	06	0
AL60-LED-HF – Lights for moisture-proof with (HF-) microwave detector	X	-	35 W	3900 lm	4000 K	X					X			65	06	0



# Biodynamic light

## Tunable white LED panel lights with attractive design

The extremely flat housing of the PL1 and PL2 LED panel lights is suitable for installation in modular ceilings with reduced mounting depth. The diffuser is very evenly illuminated and provides the room with a pleasant distribution of light. The lights are also available with a microprismatic cover, which gives glare suppression to  $UGR < 19$ .

The LED driver conforms to the latest DALI Device Type 8 standard for Tunable White. Not only can the LED panels be dimmed, but the colour temperature can be set as required from warm white (2700 K) to cool white (6500 K).

These lights are therefore ideal for "Human Centric Lighting" (HCL). This type of control alters the light output as well as the colour temperature over the course of the day. It means that people are in tune with natural daylight. Biodynamic control of these lights is very simple with the B.E.G. HCL occupancy detector (PD4-M-HCL) or with other DALI HCL systems that support Device Type 8.



# LED panel light

## Product and accessory

### Description

PL1-625-LED-DALI-TW-S  
 PL1-625-LED-AG-DALI-TW

### Colour

silver  
 white

### Part number

93681  
 93094

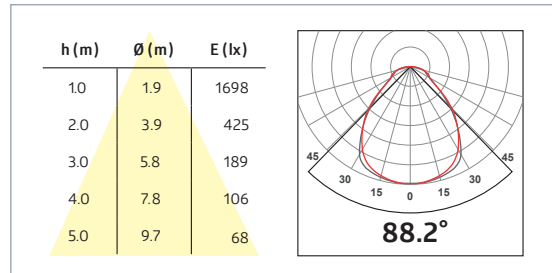
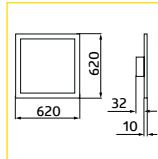

6000 K

4000 K

3000 K

## Product information

- Very flat square LED panel light
- For installation into suspended ceilings module 625
- Light colour adjustable from 2900 K to 6800 K
- DALI driver Device Type 8 for controlling the light temperature
- Good glare reduction thanks to microprismatic structure UGR < 19 (93094)
- Very uniform brightness of the luminaire

## Technical data

### Light

LED circuit board securely mounted  
 Selectable colour temperatures:  
 3000 K warm white (3450 lm, 77 lm/W)  
 to 6000 K cool white (3550 lm, 79 lm/W)



CRI: 82 / TM30: 81

UGR < 19 (93094)

200 - 240 V AC 50/60 Hz

45 W / PF 0.89

IP20 / Class II

-20 °C to +40 °C

white or silver frame

Appearance: plastic diffuser white

620 x 620 x 10 mm

## PL1-600-LED

## LED panel light

### Product and accessory

Description	Colour	Part number
PL1-600-LED-AG-DALI-TW-S	silver	93151
PL1-600-LED-AG-DALI-TW	white	93084

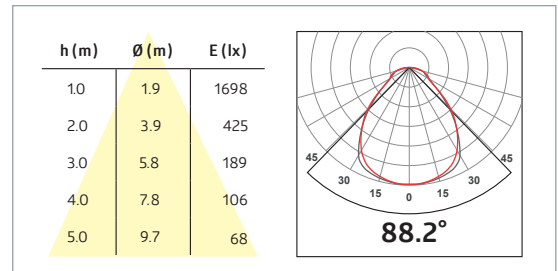
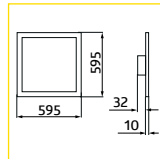

### Product information

- Very flat square LED panel light
- For installation into suspended ceilings module 600
- Light colour adjustable from 3000 K to 6000 K
- DALI driver Device Type 8 for controlling the light temperature
- Good glare reduction thanks to microprismatic structure UGR < 19
- Very uniform brightness of the luminaire

### Technical data

#### Light

LED circuit board securely mounted  
 Selectable colour temperatures:  
 3000 K warm white (3450 lm, 77 lm/W)  
 to 6000 K cool white (3550 lm, 79 lm/W)



CR1: 82 / TM30: 81

UGR < 19

200 - 240 V AC 50/60 Hz

45 W / PF 0.89

IP20 / Class II

-20 °C to +40 °C

white or silver frame

Appearance: plastic diffusor white

595 x 595 x 10 mm

# LED panel light

## Product and accessory

### Description

PL1-31125-LED-AG-DALI-TW

### Colour

white

### Part number

93077

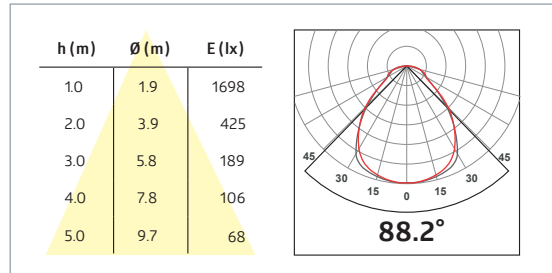
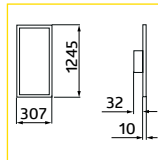

6500 K

4000 K

2700 K

## Product information

- Very flat LED panel light
- For installation into suspended ceilings module 312
- Light colour adjustable from 2700 K bis 6500 K
- DALI driver Device Type 8 for controlling the light temperature
- Good glare reduction thanks to microprismatic structure UGR < 19
- Very uniform brightness of the luminaire

## Technical data

### Light

LED circuit board securely mounted  
 Selectable colour temperatures:  
 2700 K warm white (3650 lm, 81 lm/W)  
 to 6500 K cool white (4050 lm, 90 lm/W)



CRI: 82 / TM30: 81

UGR < 19

200 - 240 V AC 50/60 Hz

45 W / PF 0.89

IP20 / Class II

-20 °C to +40 °C

white aluminium frame

Appearance: plastic diffuser white

PL1-31125: 307 x 1245 x 10 mm (module 312)

Product and accessory

Description	Colour	Part number
PL1-30120-LED-AG-DALI-TW	white	93066

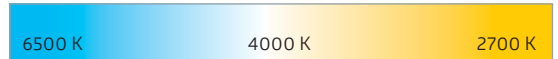
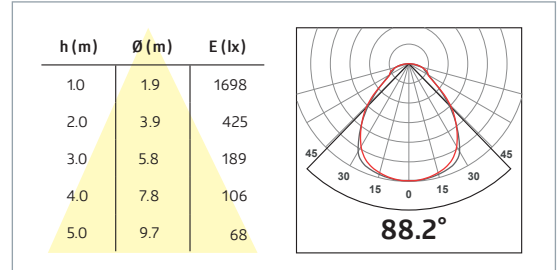
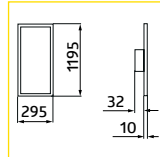

Product information

- Very flat LED panel light
- For installation into suspended ceilings module 300
- Light colour adjustable from 2700 K bis 6500 K
- DALI driver Device Type 8 for controlling the light temperature
- Good glare reduction thanks to microprismatic structure UGR < 19
- Very uniform brightness of the luminaire

Technical data

Light

LED circuit board securely mounted  
 Selectable colour temperatures:  
 2700 K warm white (3650 lm, 81 lm/W)  
 to 6500 K cool white (4050 lm, 90 lm/W)



CRI: 82 / TM30: 81

UGR < 19

200 - 240 V AC 50/60 Hz

45 W / PF 0.89

IP20 / Class II

-20 °C to +40 °C

white aluminium frame

Appearance: plastic diffusor white

295 x 1195 x 10 mm

# LED panel light

## Product and accessory

Description	Colour	Part number
PL2-30120D-LED-AG-DALI-TW	white	93667

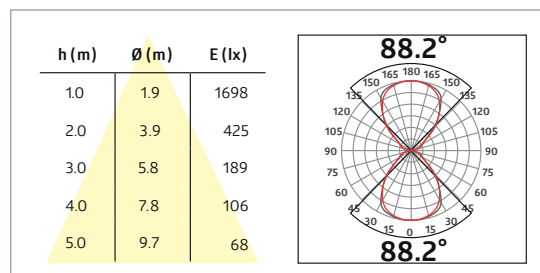
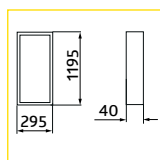

6500 K      4000 K      2700 K

## Product information

- Suspended LED panel lights
- Direct and indirect lighting can be controlled separately
- Light colour adjustable from 2700 K to 6500 K
- DALI driver Device Type 8 for controlling the light temperature
- Good glare reduction thanks to microprismatic structure UGR < 19
- Very uniform brightness of the luminaire

## Technical data

### Leuchte

LED circuit board securely mounted  
 Selectable colour temperatures:  
 2700 K warm white (7300 lm, 81 lm/W)  
 to 6500 K cool white (8100 lm, 90 lm/W)



CRI: 82 / TM30: 81

UGR < 19

200 - 240 V AC 50/60 Hz

45 W / PF 0.89

IP20 / Class II

-20 °C to +40 °C

white aluminium frame

Appearance: plastic diffuser white



295 x 1195 x 40 mm

### Product and accessory

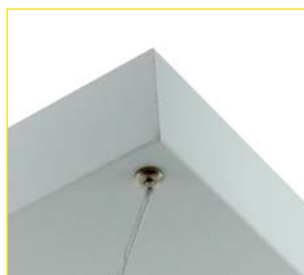
Description	Colour	Part number
Securing wires 1000 mm	-	93115
Ceiling mounting frame for modular systems module 600 mm	-	93099
Ceiling mounting frame for modular systems module 625 mm	-	93181
Mounting bracket set 4 pieces	-	93117
Pendant kit, 1000 mm, 1 ceiling rose	-	93090
Pendant kit, 1000 mm, 4 ceiling fastenings	-	93173





### Securing wires

-  1 galvanised steel cable
-  Length 1000 mm



- Can be combined as required with PL1 panel lights

### Ceiling mounting frame

-  Aluminium white
-  612 x 612 x 60 mm (93099)
-  632 x 632 x 60 mm (93181)



- Can be combined as required with PL1 panel lights

### Mounting bracket set

-  Galvanised steel
-  4 spring clips



- Can be combined as required with PL1 panel lights

### Pendulum set with ceiling rose

-  4 galvanised steel, ceiling rose, steel case white
-  Length 1000 mm,
-  Ceiling rose 295 x 295 x 50 mm

- Can be combined as required with PL1 panel lights

### Pendulum set with ceiling fixings

-  4 galvanised steel cables
-  Length 1000 mm

- Can be combined as required with PL1 panel lights

Extremely  
high light  
output



red, part no. 93121

grey, part no. 93120

## Safetylux portable LED

### Portable emergency lights with LED technology

- Portable LED safety spotlight with following functions: emergency light | torch | orientation light | warning light with blink function
- Head tiltable through 120°
- Extremely high-performance LED spotlight with range of up to 150 m (>1 lx)
- Environmentally-friendly NiMH battery with deep discharge protection

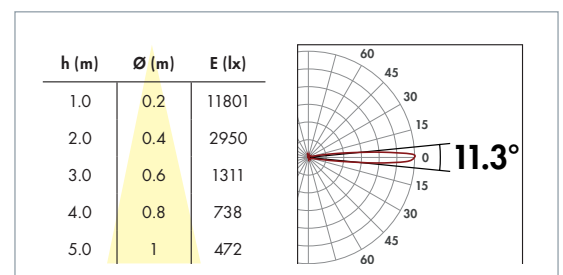
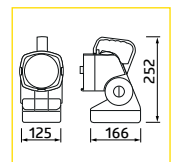



# LED Indoor lights

## Modern interior lighting

A recent development in the field of motion detection is the use of microwave technology for lighting with motion detectors. The use of this technology, at a frequency of 5.8 GHz, offers temperature-independent motion detection with extremely short response times. As detection is also possible through walls, sensor lights of this type lend themselves especially well to applications with no direct line of sight.

B.E.G. LED lights with microwave technology retain their original design, as the integrated motion detector is not visible. The installation procedure for ceiling and wall lights is just as quick as with ordinary lights.

Save energy indoors by using B.E.G. LED lights with microwave technology!



Indoor lights



Intelligent B.E.G. microwave technology

- High-performance intelligent (HF) microwave detector with many adjustment options
- Wireless communication between lights in a group
- Program and read all data of the light via the B.E.G. smartphone app plus IR adapter
- Simple transfer of all selected parameters to additional lights
- Read light and software data

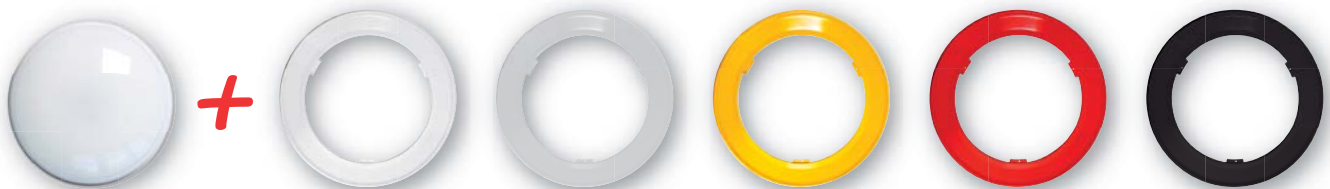

AL22-LED  
(Design ring to be ordered separately)

38140

38141

38142

38143

38144

## Product and accessory

Description	Colour	Part number
AL22-LEDN-HFR with (HF-) microwave detector, without design ring	white	91733
AL22-LEDN without (HF-) microwave detector, without design ring	white	91743
AL22-LEDW without (HF-) microwave detector, without design ring	white	91744
Design rings (order separately)	white/ white-aluminium/ melon yellow/ fire red/ anthracite	38140/ 38141/ 38142/ 38143/ 38144
IR-Adapter for Smartphones	black	92726

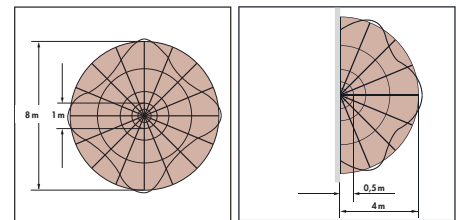
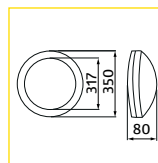

- ① Walking across or towards  
The range depends on size and speed of the object.

h (m)	Ø (m)	E (lx)
1.0	3.1	645
2.0	6.1	161
3.0	9.2	72
4.0	12.2	40
5.0	15.3	26

113.5°

## Product information

- Flat round LED lights for wall or ceiling mounting with (HF-) microwave radar detector
- Sturdy plastic case
- Replaceable outer ring in five standard colours (order separately)
- Easy mounting of base with electrical connection, insertion of light, secure case closing with special hidden screws
- High energy efficiency and long life using premium-quality LED technology and good thermal management
- Broad light distribution using diffuse light cover
- High-performance intelligent microwave detector with many adjustment options
- Wireless communication between lights in a group
- Program and read all light data via the B.E.G. smartphone app and IR-Adapter
- Activation of orientation light, as well as setting of follow-up time and dimming value

## Technical data

## Light

LED circuit board securely mounted  
Colour temperature:  
AL22-LEDN-HFR: 4000 K neutral white  
Luminous flux of LED: 2150 lm  
Luminous flux of luminaire: 1750 lm  
Peak: 646 cd  
Efficiency: 83 lm/W



CRI: 84.9 / TM30: 83.8

110 - 240 V AC 50 / 60 Hz

21 W / PF 0.86

IP54 / Class I

IK06 (1,0 Joule)

-20 °C to +40 °C

UV-resistant polycarbonate case, cover and outer ring.

Heatsink and LED circuit board consist of aluminum

Appearance: polycarbonate diffuser, white

Ø 350 x 80 mm

Photobiological safety RG0

Microwave detector

vertical 360°

5,8 GHz, wireless communication: 868 MHz

Ø 1 - 8 m

10 - 2000 Lux

Main light: 10 s - 240 min

Orientation light: 0 s - 240 min, Permanent

IR-Adapter for Smartphones (Apple/ Samsung)

# LED indoor lights

## Product and accessory

Description	Colour	Part number
L8-LEDN-HF with (HF-) microwave detector	white	94455
L8-LEDN without (HF-) microwave detector	white	94456

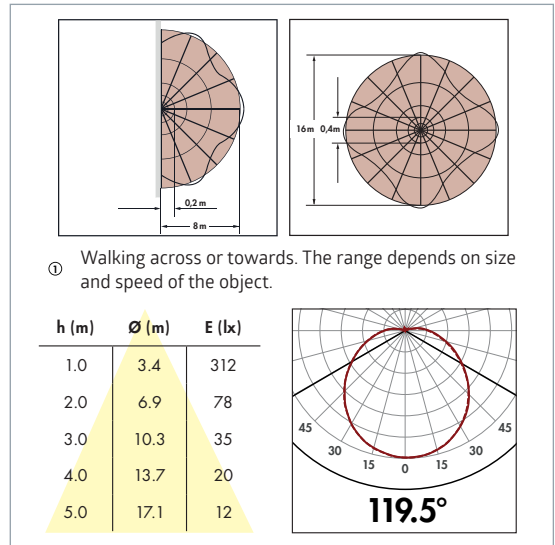
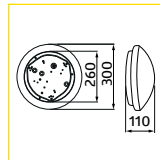

## Product information

- Round LED light for wall or ceiling mounting with integrated microwave detector
- Good energy efficiency and long life using premium-quality LED technology
- Broad light distribution using diffuse light cover
- Extremely short response time
- Microwave detector not visible from the outside
- Range, switch-on threshold and follow-up time may be set with a potentiometer
- Optional connection of additional lights controlled by the one microwave detector

## Technical data

### Light

- LED LED circuit board securely mounted
- Colour temperature: 4000 K neutral white
- Luminous flux of LED: 1400 lm
- Luminous flux of light: 1000 lm
- Peak: 312 cd
- Efficiency: 83 lm/W

- CRI/TM30 CRI: 81,3 / TM30: 80,4
- 230 V AC +/- 10 % 50 / 60 Hz
- 12 W / PF 0.94
- IP/IP40 / Class I

- IK IK02 (0,2 Joule)
- Temperature -20 °C to +40 °C
- Coated sheet steel case with LED circuit board, plastic cover
- Appearance: PMMA diffuser, white
- Ø 300 x 110 mm
- RG Photobiological safety RGO

### Microwave detector

- 1200 W, cos phi = 1
- 600 VA, cos phi = 0.5
- vertical 360°
- 5,8 GHz, <10 mW
- Ø 0.4 - 16 m
- 2 - 2000 Lux
- 5 s - 15 min

## L9-LEDN-HF

## LED indoor lights

### Product and accessory

Description	Colour	Part number
L9-LEDN-HF with (HF-) microwave detector	white	94457
L9-LEDN without (HF-) microwave detector	white	94458

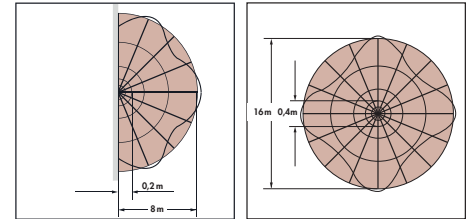
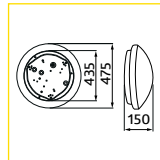

① Walking across or towards. The range depends on size and speed of the object.

h (m)	Ø (m)	E (lx)
1.0	3.7	559
2.0	7.5	140
3.0	11.2	62
4.0	15.0	35
5.0	18.7	22

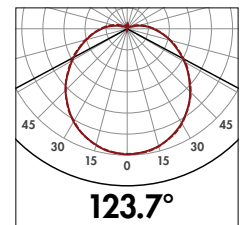

### Product information

- Round LED light for wall or ceiling mounting with integrated microwave detector
- Good energy efficiency and long life using premium-quality LED technology
- Broad light distribution using diffuse light cover
- Extremely short activation time
- Microwave detector not visible from the outside
- Range, switch-on threshold and follow-up time may be set with a potentiometer
- Optional connection of additional lights controlled by the one microwave detector

### Technical data

#### Light

LED circuit board securely mounted

Colour temperature:

L9-LEDN-HF: 4000 K neutral white

L9-LEDW-HF: 3000 K warm white

Luminous flux of LED: 2800 lm

Luminous flux of luminaire: 2200 lm

Peak: 559 cd

Efficiency: 92 lm/W



CRI: 82,1 / TM30: 81,5

230 V AC +/- 10 % 50 / 60 Hz

24 W



IP40 / Class I



IK02 (0,2 Joule)



-20 °C to +40 °C



Coated sheet steel case with LED circuit board, plastic cover



Appearance: PMMA-Diffusor white



Ø 475 x 150 mm



Photobiological safety RG0

Microwave detector

1200 W, cos phi = 1

600 VA, cos phi = 0.5



vertical 360°



5,8 GHz, <10 mW



Ø 0.4 - 16 m



2 - 2000 Lux



5 s - 15 min

## LED indoor lights

## Product and accessory

Description	Colour	Part number
AL8-25-300-LEDN-HF	white	93631
AL8 protection ring	white	93014

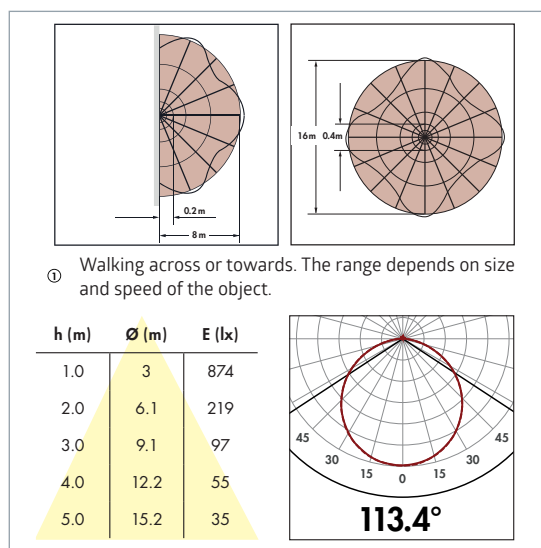
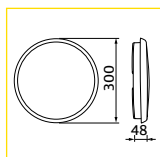

## Product information

- Extremely flat round LED light for wall or ceiling mounting
- Robust plastic case (polycarbonate) with high fire protection rating
- Integrated (HF-) microwave sensor, not visible from the outside, wide detection range
- DIP switches to set follow-up time, switch-on threshold and sensor sensitivity.
- Energy efficient light with long service life >40,000 hours
- Broad light distribution using diffuse light cover
- Simple mounting with separate mounting bracket
- Protector ring against vandalism available as accessory

## Technical data

## Light

LED	LED circuit board securely mounted Colour temperature: 4000 K neutral white Luminous flux of light: 2100 lm Peak: 864 cd Efficiency: 84 lm/W
CRI TM30	CRI: 84 / TM30: 82
⌚	200 - 240 V AC 50 Hz
⏻	25 W / PF 0.91
IP	IP20 / Class II
IK	IK08 (5.0 Joule)
🔥	Class V0
🌡️	-15 °C to +35 °C
📦	Impact and UV-resistant polycarbonate Appearance: polycarbonate diffuser, white
📏	Ø 300 x 48 mm
RG	Photobiological safety RGO
	Microwave detector
📶	vertical 360°
📶	5.8 GHz, <10 mW
📶	Ø 2 - 12 m
🌞	inactive / 5 - 50 Lux
🕒	20 s - 10 min

### Product and accessory

Description	Colour	Part number
AL8-25-300-LED-3C	white	93621

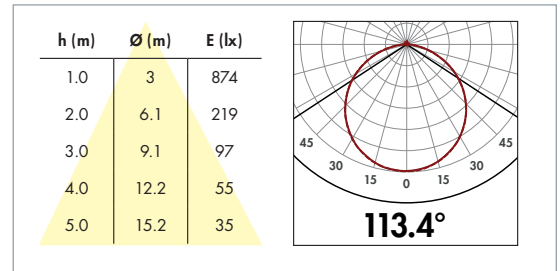
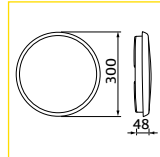

5700 K	4000 K	3000 K
--------	--------	--------

### Product information

- Extremely flat round LED light for wall or ceiling mounting
- Robust and water-resistant plastic case (polycarbonate) with high fire protection rating
- Three colours in one light, switchable selection between warm, neutral or daylight white illumination
- Energy efficient light with long service life >40,000 hours
- Broad light distribution using diffuse light cover
- Every colour temperature is externally dimmable
- Simple mounting with separate mounting bracket
- Protector ring against vandalism available as accessory

### Technical data

#### Light

LED circuit board securely mounted  
 Selectable colour temperatures:  
 3000 K warm white (2000 lm, 80 lm/W)  
 4000 K neutral white (2100 lm, 84 lm/W)  
 5700 K cool white (2120 lm, 85 lm/W)



CRI: 84 / TM30: 82

200 - 240 V AC 50 Hz

25 W PF 0.91

IP54 / Class II

IK08 (5.0 Joule)

Class V0

-15 °C to +35 °C

Impact and UV-resistant polycarbonate

Appearance: polycarbonate diffuser, white

Ø 300 x 40 mm

Photobiological safety RG0

## LED indoor lights

## Product and accessory

Description	Colour	Part number
AL8-25-300-LED-3C-HF	white	93141
AL8 protection ring	white	93014

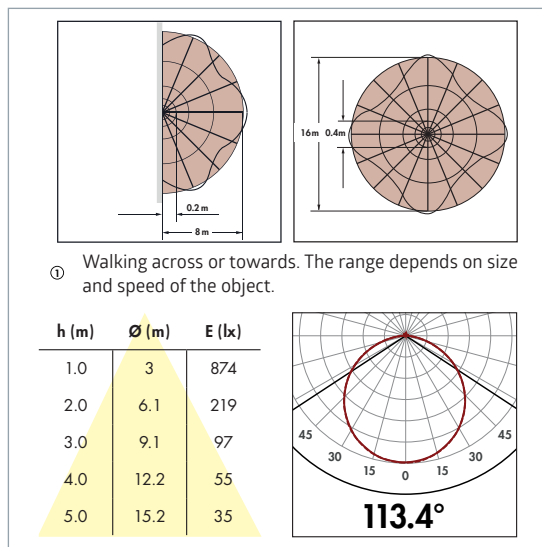
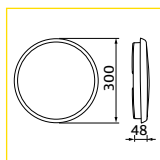

5700 K

4000 K

3000 K

## Product information

- Extremely flat round LED light for wall or ceiling mounting
- Robust plastic case (polycarbonate) with high fire protection rating
- Three colours in one light, switchable selection between warm, neutral or daylight white illumination
- Integrated (HF-) microwave sensor, not visible from the outside, wide detection range
- DIP switches to set follow-up time, switch-on threshold and sensor sensitivity
- Energy efficient light with long service life >40,000 hours
- Broad light distribution using diffuse light cover
- Easy mounting with separate mounting bracket
- Protector ring against vandalism available as accessory

## Technical data

## Light

LED circuit board securely mounted  
Selectable colour temperatures:

- 3000 K warm white (2000 lm, 80 lm/W)
- 4000 K neutral white (2100 lm, 84 lm/W)
- 5700 K cool white (2120 lm, 85 lm/W)

CRI: 84 / TM30: 82

200 - 240 V AC 50 Hz

25 W / PF 0.91

IP20 / Class II

IK08 (5.0 Joule)

Class V0

-15 °C to +35 °C

Impact and UV-resistant polycarbonate  
Appearance: polycarbonate diffuser, white

Ø 300 x 48 mm

Photobiological safety RG0

Microwave detector

vertical 360°

5.8 GHz, &lt;10 mW

Ø 2 - 12 m

inactive / 5 - 50 Lux

20 s - 10 min



# AL12-25-300-LED-3C

## LED indoor lights

### Product and accessory

Description	Colour	Part number
AL12-25-300-LED-3C	white	93615

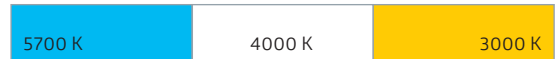
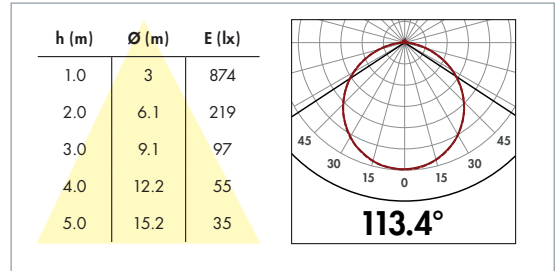
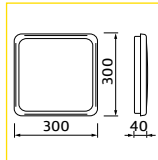

### Product information

- Extremely flat LED light for wall or ceiling mounting
- Robust plastic case (polycarbonate) with high fire protection rating
- Three colours in one light, switchable selection between warm, neutral or daylight white illumination
- Energy efficient light with long service life >40,000 hours
- Broad light distribution using diffuse light cover
- Every colour temperature is externally dimmable
- Easy mounting with separate mounting bracket

### Technical data

#### Light

LED circuit board securely mounted  
 Selectable colour temperatures:



3000 K warm white (2000 lm, 80 lm/W)  
 4000 K neutral white (2100 lm, 84 lm/W)  
 5700 K cool white (2120 lm, 85 lm/W)



CRI: 84 / TM30: 82



200 - 240 V AC 50 Hz



25 W PF 0.91



IP54 / Class II



IK08 (5.0 Joule)



Class V0



-15 °C to +35 °C



Impact and UV-resistant polycarbonate  
 Appearance: polycarbonate diffuser, white



300 x 300 x 40 mm



Photobiological safety RGO

# LED indoor lights

## Product and accessory

### Description

AL12-25-300-LED-3C-HF

### Colour

white

### Part number

93145

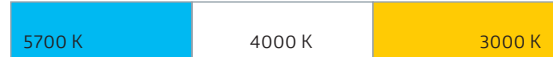
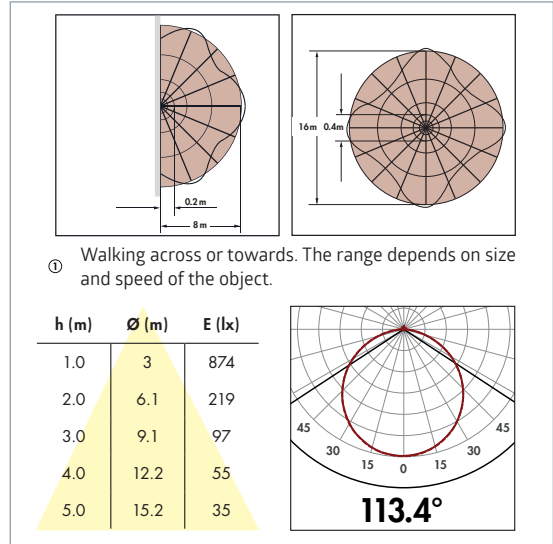
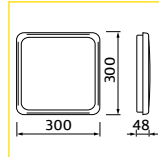

## Product information

- Extremely flat LED light for wall or ceiling mounting
- Robust plastic case (polycarbonate) with high fire protection rating
- Three colours in one light, switchable selection between warm, neutral or daylight white illumination
- Integrated (HF-) microwave sensor, not visible from the outside, wide detection range
- DIP switches to set follow-up time, switch-on threshold and sensor sensitivity
- Energy-efficient light with a long service life >40,000 h
- Broad light distribution using diffuse light cover
- Easy mounting with separate mounting bracket

## Technical data

### Light

LED circuit board securely mounted  
 Selectable colour temperatures:  
 3000 K warm white (2000 lm, 80 lm/W)  
 4000 K neutral white (2100 lm, 84 lm/W)  
 5700 K cool white (2120 lm, 85 lm/W)



CRI: 84 / TM30: 82

200 - 240 V AC 50 Hz

25 W / PF 0.91

IP20 / Class II

IK08 (5.0 Joule)

Class V0

-15 °C to +35 °C

Impact and UV-resistant polycarbonate  
 Appearance: polycarbonate diffuser, white

300 x 300 x 48 mm

Photobiological safety RGO

### Microwave detector



vertical 360°



5.8 GHz, <10 mW



Ø 2 - 12 m



inactive / 5 - 50 Lux



20 s - 10 min

## HF-L7 and -L8

## LED indoor lights

### Product and accessory

Description	Colour	Part number
HF-L7 round light PC with (HF-) microwave detector	white	94450
HF-L8 round light PMMA with (HF-) microwave detector	white	94445
L7 round light PC without (HF-) microwave detector	white	94451
L8 round light PMMA without (HF-) microwave detector	white	94446
Energy-saving lamp E27 - 15W (replaces conventional 60W bulb), Energy-class A	-	38158
LED lamp E27 -10W / E27 (replaces conventional 60W bulb), Energy efficiency class A+	-	38157

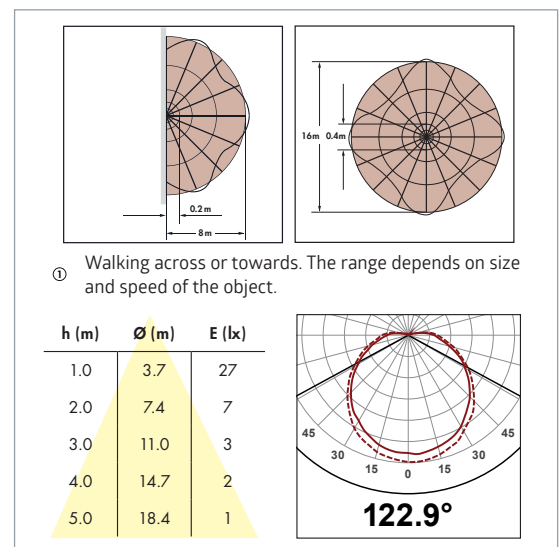
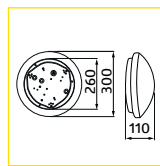

### Product information

- Wall and ceiling light with integrated microwave detector
- Range, switch-on threshold and follow-up time may be set with a potentiometer
- Extremely short activation time
- Possibility to connect other lights which are also controlled by the one microwave detector
- Polycarbonate is appropriate for areas where greater impact resistance is required (e.g. schools, public buildings)
- Lamp not included

### Technical data

#### Light

- E27 max. 23 W with E27 bulb socket
- 230 V AC +/- 10 % 50 / 60 Hz
- IP40 / Class I

- IK06 HF-L8: IK02 (0.2 Joule)
- HF-L7: IK06 (1.0 Joule)

- -10 °C to +40 °C

- HF-L8: Acrylic glass
- HF-L7: Polycarbonate

- Ø 300 x 110 mm

#### Microwave detector

- 1200 W, cos phi = 1
- 600 VA, cos phi = 0.5
- vertical 360°
- 5.8 GHz, <10 mW
- Ø 0.4 - 16 m
- 2 - 2000 Lux
- 5 s - 15 min

# LED indoor lights

## Product and accessory

Description	Colour	Part number
HF-L11 round light PMMA with (HF-) microwave detector	white	94447
L11 round light PMMA without (HF-) microwave detector	white	94448
Energy-saving lamp E27 - 15W (replaces conventional 60W bulb), Energy-class A	-	38158
LED lamp E27 -10W / E27 (replaces conventional 60W bulb), Energy efficiency class A+	-	38157

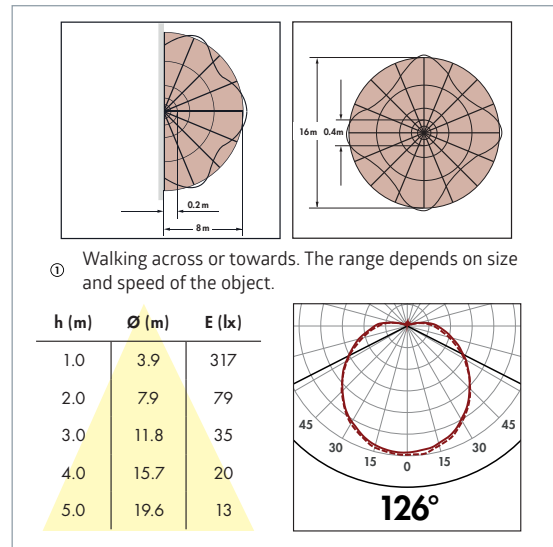
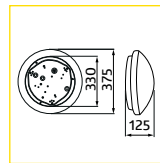

## Product information

- Wall and ceiling light with integrated microwave detector
- Range, switch-on threshold and follow-up time may be set with a potentiometer
- Extremely short activation time
- Possibility to connect other lights which are also controlled by the one microwave detector
- Supply without lamp

## Technical data

### Light

- E27 max. 2x 23 W with E27 bulb sockets
- ⊖ 230 V AC +/- 10 % 50 / 60 Hz
- IP ⊕ IP40 / Class I
- IK IK02 (0.2 Joule)
- ⊖ -10 °C to +40 °C
- Acrylic glass
- ↕ Ø 375 x 125 mm
- Microwave detector
- ⚡ 1200 W, cos phi = 1  
600 VA, cos phi = 0.5
- ⦶ vertical 360°
- 📡 5.8 GHz, <10 mW
- 📐 Ø 0.4 - 16 m
- ⊙ 2 - 2000 Lux
- 🕒 5 s - 15 min

## Product and accessory

Description	Colour	Part number
HF-L1 round light Glass with (HF-) microwave detector	white	94440
L1 round light Glass without (HF-) microwave detector	white	94453
Sealing ring IP54 HF-L1	-	37849
Energy-saving lamp E27 - 15W (replaces conventional 60W bulb), Energy-class A	-	38158
LED lamp E27 -10W / E27 (replaces conventional 60W bulb), Energy efficiency class A+	-	38157

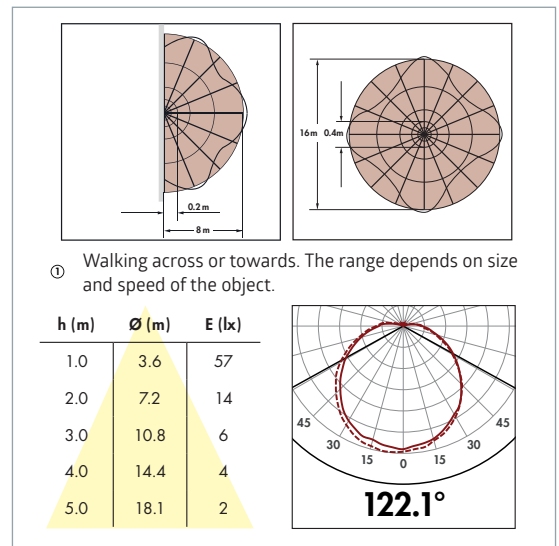
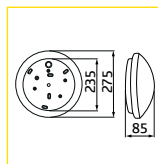

## Product information

- Wall and ceiling light with integrated microwave detector
- Range, switch-on threshold and follow-up time may be set with a potentiometer
- Extremely short activation time
- Possibility to connect other lights which are also controlled by the one microwave detector
- Supply without lamp

## Technical data

### Light

- max. 23 W with E27 bulb socket
- 230 V AC +/- 10 % 50 / 60 Hz
- IP40 / Class I
- IK02 (0.2 Joule)
- 10 °C to +40 °C
- silk-mat glass
- Ø275 x 85 mm

### Microwave detector

- 1200 W, cos phi = 1
- 600 VA, cos phi = 0.5
- vertical 360°
- 5.8 GHz, <10 mW
- Ø 0.4 - 16 m
- 2 - 2000 Lux
- 5 s - 15 min



PD4-M-HCL-SM part no. 93007  
PD4-M-HCL-FC part no. 93006



## All-in-one lighting control system PD4-M-HCL for PL1-LED-DALI-TW

### Tunable white panel lights and occupancy detectors

- LED panel lights in very flat design for installation in suspended ceiling systems, with colour temperature adjustable from 2700 K to 6500 K
- Bidirectional occupancy detector with integrated DALI controller for energy-efficient and biologically effective lighting control (Human Centric Lighting)
- HCL technology: Daylight-dependent control of brightness and colour temperature with real-time clock
- Option of "PureColour" external colour temperature light sensor

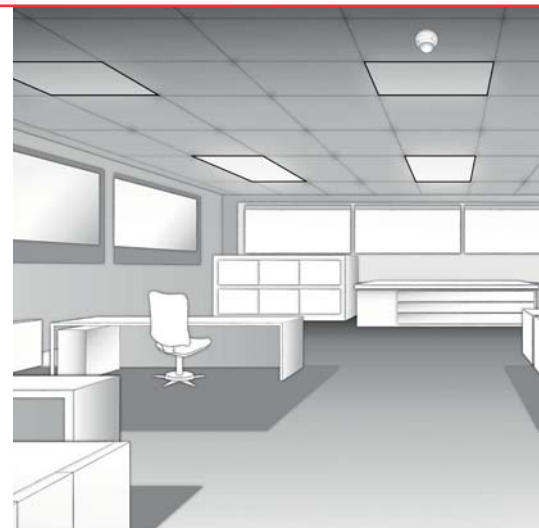

# LED-Downlights

## Accent lighting with built-in LED downlights

The design of these extremely flat LED downlights for interior use provides an even but accentuated distribution of light in the room, to highlight the features of an architecturally sophisticated setting.

The robust plastic case is splash-resistant on its underside, enabling installation in commercial spaces with high humidity, e.g. shower rooms.

A slide switch on the device offers a choice of three colour temperatures, warm white (3000 K), neutral white (4000 K) or daylight white (5700 K). Each colour temperature is also externally dimmable. Built into the ceiling and suitable for any arrangement of room, they let you create an individual lighting atmosphere.



## DL10-18-172-LED-3C

# LED Downlights

### Product and accessory

#### Description

DL10-18-172-LED-3C

#### Colour

white

#### Part number

93098

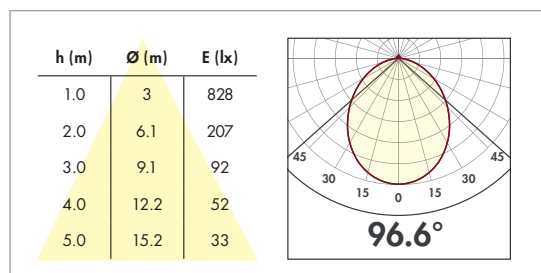
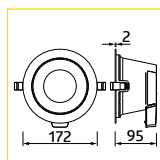

5700 K

4000 K

3000 K

### Product information

- LED-Downlight for false ceiling mounting
- Sturdy plastic case with integrated ballast
- Broad light distribution using diffuse light cover
- Very flat, white cover ring
- Splash-proof on the underside (IP54), top housing IP40
- Three colours in one light, switchable selection between warm, neutral or daylight white illumination
- Energy-efficient light with long service life >50,000 hours
- Every colour temperature is externally dimmable
- Simple mounting and electrical connection

### Technical data

#### Light

LED circuit board securely mounted

Selectable colour temperatures:

- LED 3000 K warm white (2000 lm, 80 lm/W)
- 4000 K neutral white (2100 lm, 84 lm/W)
- 5700 K cool white (2120 lm, 85 lm/W)

Peak: 830 cd

CRI: 83 / TM30: 81

200 - 240 V AC 50/60 Hz

18 W / PF 0.95

IP40 / Class II

-15 °C to +35 °C

Plastic, Optik: Diffusor white

Ø 172 x 95 mm

Mounting opening Ø 150 - 165 mm

Photobiological safety RGO



## Product and accessory

## Description

DL11-18-172-LED-3C

## Colour

white

## Part number

93128

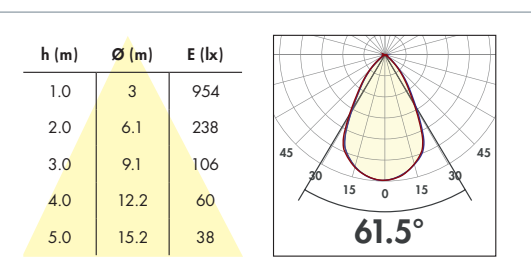
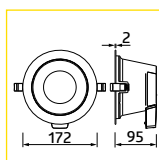

5700 K

4000 K

3000 K

## Product information

- LED-Downlight for false ceiling mounting
- Sturdy plastic case with integrated ballast
- Aluminium reflector with good glare reduction UGR<19
- Very flat, white cover ring
- Splash-proof on the underside (IP54), top housing IP40
- Three colours in one light, switchable selection between warm, neutral or daylight white illumination
- Energy-efficient light with long service life >50,000 hours
- Every colour temperature is externally dimmable
- Simple mounting and electrical connection

## Technical data

## Light

LED circuit board securely mounted

Selectable colour temperatures:

- 3000 K warm white (2000 lm, 80 lm/W)
- 4000 K neutral white (2100 lm, 84 lm/W)
- 5700 K cool white (2120 lm, 85 lm/W)

Peak: 1530 cd

CRI: 83 / TM30: 82

200 - 240 V AC 50/60 Hz

18 W / PF 0.95

IP40 / Class II

UGR &lt; 19

-15 °C to +35 °C

Plastic, Optics: Aluminium reflector

Ø 172 x 95 mm

Mounting opening Ø 150 - 165 mm

Photobiological safety RG0

## LED Downlights

## Product and accessory

## Description

DL12-18-172-LED-3C

## Colour

white

## Part number

93168

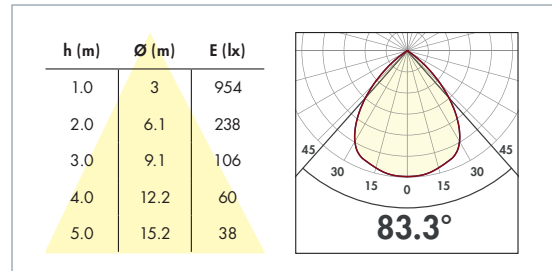
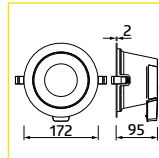

5700 K

4000 K

3000 K

## Product information

- LED-Downlight for false ceiling mounting
- Sturdy plastic case with integrated ballast
- Aluminium reflector with facets for good glare reduction
- Very flat, white cover ring
- Splash-proof on the underside (IP54), top housing IP40
- Three colours in one light, switchable selection between warm, neutral or daylight white illumination
- Energy-efficient light with long service life >50,000 hours
- Every colour temperature is externally dimmable
- Simple mounting and electrical connection

## Technical data

## Light

LED circuit board securely mounted

Selectable colour temperatures:



3000 K warm white (2000 lm, 80 lm/W)

4000 K neutral white (2100 lm, 84 lm/W)

5700 K cool white (2120 lm, 85 lm/W)

Peak: 975 cd



CRI: 83 / TM30: 81



200 - 240 V AC 50/60 Hz



18 W / PF 0.95



IP40 / Class II



-15 °C to +35 °C



Plastic, optics: faceted aluminium reflector

Ø 172 x 95 mm



Mounting opening Ø 150 - 165 mm



Photobiological safety RGO

# LED occupancy detector

## Motion detection combined with orientation lighting

For the first time, the functionality of a ceiling occupancy detector is being combined with LED orientation lighting in a single housing with this new development. The LED orientation lighting is designed here as an illuminated ring around the sensor lens. After automatic switch-off of the main light, the orientation light can be activated for an adjustable time or even permanently.

The occupancy detector with a detection range of 10 m provides a variety of options for individual adaptation to the local conditions in addition to the integrated daylight control.

All parameters can be set to values suitable to individual needs and read out via compatible smartphones using the B.E.G. remote control app in combination with the IR adapter.

To extend the occupancy detector's range, it can simply be connected to additional PD2N-LED configured as slave devices. The combination of orientation lighting and automatic lighting control provides a considerable increase in comfort and energy savings.



# Occupancy detector with LED orientation light

## PD2N-M-1C-LED

### Product and accessory

Description	Colour	Part number
PD2N-M-1C-LED-FC	white	94055
IR-Adapter for Smartphones	black	92726
RC-Arc extinction kit	white	10880
Mini-RC-Arc extinction kit	black	10882

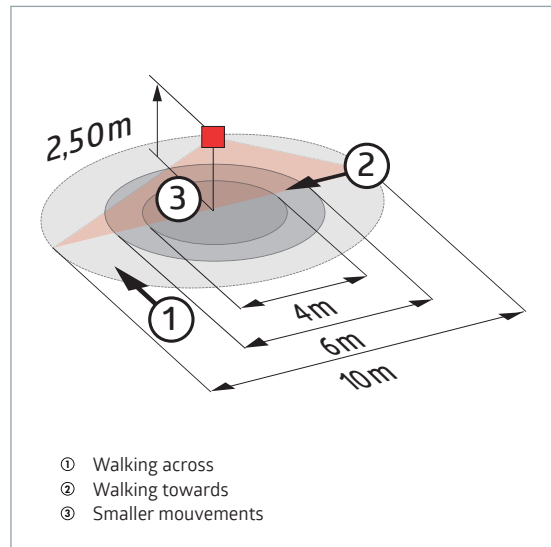
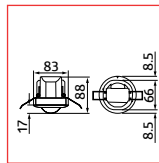

### Product information

- Remote control-capable occupancy detector for inside use with circular detection area
- Integrated LED light as separately adjustable orientation- and night light
- One channel for light switching
- Many adjustment and reading options via the bidirectional B.E.G. Smartphone-App
- Extension of the detection range possible by using up to 5 other PD2N-M-1C-LED
- Can be used as either Master device or Slave device

### Technical data

- 110 - 240 V AC 50 / 60 Hz
- approx. 0.3 W / approx. 2 W with LED lighting
- 360°
- max. Ø 10 m across
- max. Ø 6 m towards
- max. Ø 4 m smaller movements
- 2.5 m
- IP20 / Class II
- 20 °C to +40 °C
- PC, with sensor, power supply and LED light
- IR-Adapter for Smartphones (Samsung or iPhone only), IR-PD-Mini
- Ø 83 x 88 mm
- Channel 1 (lighting control, potential-free (dry))
- 2300 W, cos φ = 1
- 1150 VA, cos φ = 0.5
- max. inrush current IP (20 ms) = 165 A
- 1x μ-contact, dry contact NO with tungsten pre-make contact
- 10 s - 18 h
- 10 - 2000 Lux
- LED orientation/-night light
- 20 % - 100 % / OFF /
- 10 s - 18 h

# LED outdoor lights

## Optimum illumination for exterior spaces

Whether for house entrances or warehouse loading bays, lighting of exterior spaces makes a major contribution to the safety of properties. For large or small spaces, for more or less light, B.E.G. has the right solution for your project.

With the right technology, LEDs make it possible to achieve a high light output with low energy consumption. The B.E.G. engineers have developed floodlights to take full advantage of this. As usual with us, in addition to energy-saving features, we put the accent on a high level of functionality twinned with easy installation and contemporary design.

The LED floodlights are available with integrated motion detector, which can also be programmed by remote control. Mounting the floodlight is as easy as can be: once the wall socket has been fastened and wired up, the floodlight head can be clipped on by hand, without requiring tools. After mounting, the head can be moved to practically any position.



# LED outdoor lights

## Product and accessory

Description	Colour	Part number
LED floodlight FL2N-LED-230 with motion detector	white	92627
LED floodlight FL2N-LED-230 with motion detector	black	92626
LED floodlight FL2N-LED without motion detector	white	92599
LED floodlight FL2N-LED without motion detector	black	92598
IR-RC	-	92000
IR-RC-Mini	-	92090
IR-Adapter for Smartphones	black	92726
Diffusion lens set FL2N	transparent/opal	38003

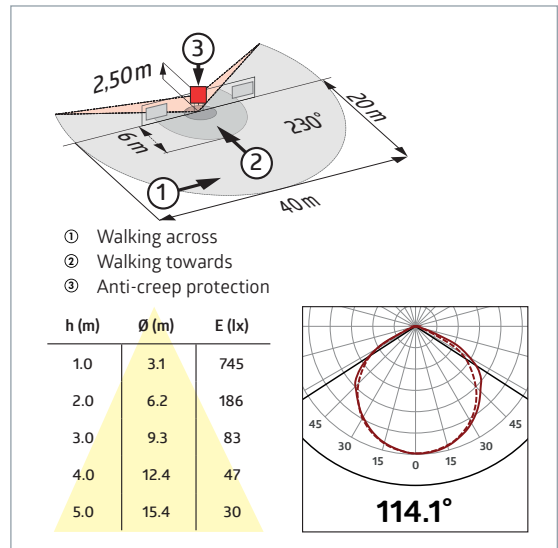
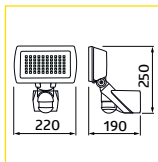

## Product information

- Pivoable LED floodlight with motion detector for exterior wall mounting
- Floodlight can be pivoted on three axes, direction can be fixed with locking device
- Highly robust cast aluminium case with corrosion-resistant stainless steel screws
- Easy mounting of base with electrical connection, insertion of light, and locking of floodlight
- High energy efficiency and long life using premium-quality LED technology and good thermal management
- Broad light distribution for even illumination of large surfaces
- PIR detector with large detection area and anti-creep zone

## Technical data

- Light**
- LED
  - LED circuit board securely mounted
  - Colour temperature: 4000 K neutral white
  - Luminous flux of light: 2100 lm
  - Peak: 1006 cd
  - Efficiency: 81 lm/W
  - CRI TM30: CRI: 84.1 / TM30: 82.8
  - 110 - 240 V AC 50 / 60 Hz
  - 26 W / PF 0.89
  - IP44 / Class I
  - IK07 (2.0 Joule)
  - 20 °C to +40 °C
  - Case die-cast aluminum, lower section UV-resistant polycarbonate
  - Appearance: glass cover, clear
  - 220 x 190 x 250 mm
  - Photobiologica safety RGO
- Motion detector**
- 2300 W, cos phi = 1
  - 1150 VA, cos phi = 0.5
  - horizontal 230°
  - max. 20 m across
  - max. 6 m towards
  - max. 4 m Anti-creep able
  - 2 - 2000 Lux
  - 15 s - 16 min, pulse
  - IR-Adapter for Smartphones, IR-RC, IR-RC-Mini

Product and accessory

Description	Colour	Part number
LED floodlight FL3N-LED-130 with motion detector	white	92629
LED floodlight FL3N-LED-130 with motion detector	black	92628
LED floodlight FL3N-LED without motion detector	white	92703
LED floodlight FL3N-LED without motion detector	black	92702
Diffusion lens set FL3N	transparent/opal	38004

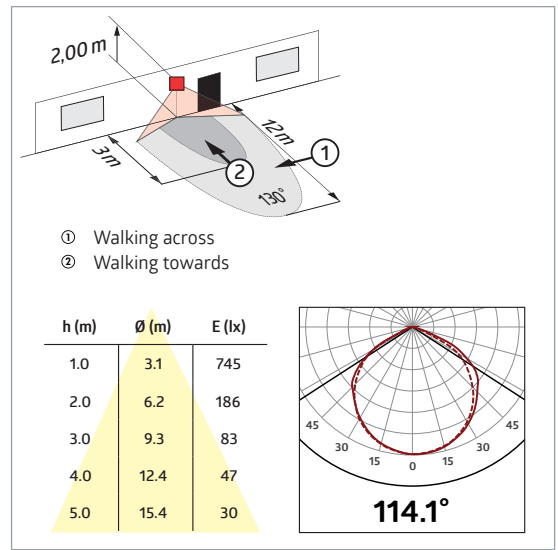
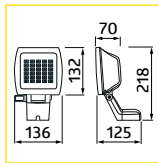

Product information

- Pivoting LED floodlight with motion detector for exterior wall mounting
- Direction can be fixed with locking device
- Highly robust cast aluminium case with corrosion-resistant stainless steel screws
- Easy mounting of base with electrical connection, insertion of light, and locking of floodlight
- High energy efficiency and long life using premium-quality LED technology and good thermal management
- Broad light distribution for even illumination of large surfaces
- Integrated motion detector with narrow detection area for paths and staircases
- Additional lights can be switched simultaneously by the one motion detector
- Settings via potentiometers

Technical data

Light

- LED
- LED circuit board securely mounted
- Colour temperature: 4000 K neutral white
- Luminous flux: 1050 lm
- Peak: 539 cd
- Efficiency: 75 lm/W
- CRI TM30: CRI: 82.8 / TM30: 82.7
- 110 - 240 V AC 50 / 60 Hz
- 14 W / PF 0.7
- IP IP44 / Class I
- IK IK05 (0.7 Joule)
- 20 °C to +40 °C
- Case die-cast aluminum, lower section UV-resistant polycarbonate
- Appearance: glass cover, clear
- 136 x 125 x 218 mm
- RG Photobiological safety RG0

Motion detector

- 1000 W, cos phi = 1
- 500 VA, cos phi = 0.5
- horizontal 130°
- max. 10 m across
- max. 3 m towards
- 5 - 2000 Lux
- 30 s - 30 min, pulse

# LED outdoor lights

## Product information and accessory

Description	Colour	Part number
ALC-B-360 SLU with motion detector	white	91301
ALC-B-360 SLU with motion detector	black	91321
ALC-K-360 with motion detector incl. system glass Crystal	white	91306
ALC-K-360 with motion detector incl. system glass Crystal	black	91326
ALC-ES corner socket	white	91305
ALC-ES corner socket	black	91325
Energy-saving lamp E27 - 15W (replaces conventional 60W bulb), Energy-class A	-	38158
LED lamp E27 -10W / E27 (replaces conventional 60W bulb), Energy efficiency class A+	-	38157
Spare glass for ALC-K	-	94115

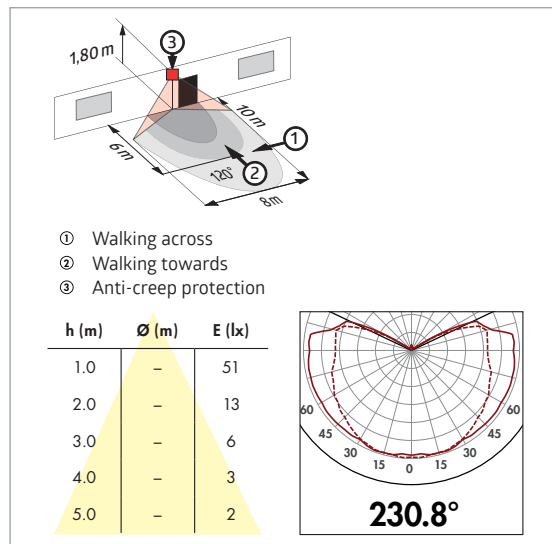
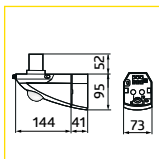

## Product information

- System light lower sections ALC-B / -K with motion detector and photoelectric switch
- Can be used as photoelectric switch thanks to holiday and comfort function
- ALC-B combinable with various system glasses. ALC-K includes system glass Crystal!
- Wall or outer corner installation
- Time-saving single-handed plug-in base installation
- Optional connection of additional lights switched by the one motion detector
- Supply without lamp

## Technical Data

### Light

- max. 100 W with E27 bulb socket
  - 230 V AC +/- 10 % 50 / 60 Hz
  - IP44 / Class II
  - 10 °C to +40 °C
  - Polycarbonate, UV-resistant
  - 73 x 95 x 185 mm
- ### Motion detector
- 1000 W, cos phi = 1
  - 500 VA, cos phi = 0.5
  - horizontal 180°
  - max. 10 m across
  - max. 6 m towards
  - max. 4 m anti-creep zone
  - 2 - 1000 Lux
  - 4 s - 10 min



## Product and Accessory

Description	Colour	Part number
SG Vienna- white	white	94113
SG Crystal- transparent	transparent	94100
SG Oslo - transparent	transparent	94101
SG Paris - transparent/white	transparent/white	94111



### SG Vienna

- Opal - glossy
- ↳ Ø 200 x H 210 mm  
support opening Ø 82 mm

- For combination with system light lower section LUXOMATIC® ALC-B-360.

### SG Crystal

- Bubble shade glass - graphit
- ↳ Ø 215 x H 220 mm  
support opening Ø 82 mm

- For combination with system light lower section LUXOMATIC® ALC-B-360.

### SG Oslo

- Bubble shade glass - Crystal
- ↳ Ø 215 x H 220 mm  
support opening Ø 82 mm

- For combination with system light lower section LUXOMATIC® ALC-B-360.

### SG Paris

- Crystal - white
- ↳ Ø 215 x H 245 mm  
support opening Ø 82 mm

- For combination with system light lower section LUXOMATIC® ALC-B-360.

## LED outdoor lights

## Product and Accessory

Description	Colour	Part number
AL1-130 with motion detector	white	91400
AL1-130 with motion detector	black	91402
AL1-130 with motion detector	brown	91401
Energy-saving lamp E27 - 15W (replaces conventional 60W bulb), Energy-class A	-	38158
LED lamp E27 -10W / E27 (replaces conventional 60W bulb), Energy efficiency class A+	■ -	38157

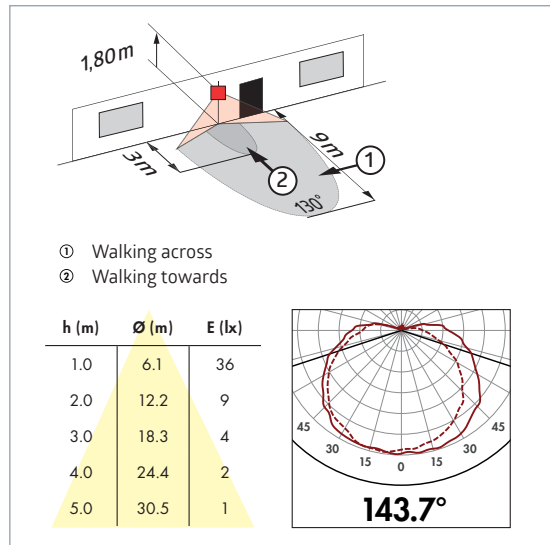
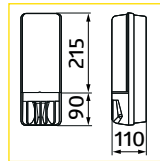

## Product information

- AL1 all-purpose light with 130° motion detector
- Additional lights can be switched simultaneously by the one motion detector
- Potentiometer for adjustment of follow-up time and switch-on threshold behind detachable cover
- Supply without lamp

## Technical data

## Light

- max. 60 W with E27 bulb socket
- 230 V AC +/- 10 % 50 / 60 Hz
- IP44 / Class II
- 10 °C to +40 °C
- Polycarbonate, UV-resistant
- 110 x 95 x 315 mm
- Motion detector**
- 1000 W, cos phi = 1
- 500 VA, cos phi = 0.5
- horizontal 130°
- max. 9 m across
- max. 3 m towards
- 2 - 1000 Lux
- 4 s - 10 min



# LED moisture-proof lights

## Safe lighting in moisture-proof applications (IP65)

In many applications, lighting must meet high levels of safety, for example in laboratories, swimming pools or underground garages. Our LED lights for moisture-proof applications have a robust, water-resistant case (protection class IP65). They are therefore highly suitable for installation in demanding environments.

As well as simple lights for moisture-proof applications, B.E.G. also offers models for fast lighting automation, which are equipped with either microwave or PIR motion detectors. This improves efficiency, as lighting is only activated when movement is detected.

The use of microwave detectors allows temperature-independent detection of movements with a very short response time. As detection is also possible through walls, they are especially suitable for applications with no direct line of sight. The HF detectors are integrated into the light and are invisible from the outside.

The PIR detectors are extremely small, but have a large detection area. The detector is fitted with an IP65 cover only 4 cm in diameter, integrated into the case.



# Moisture-Proof LED lights

## AL60-LEDN-PD9M

### Product and accessory

Description	Colour	Part number
Moisture-Proof light AL60-LEDN-PD9M with motion detector	grey	91751
Moisture-Proof light AL60-LEDN without motion detector	grey	91746
IR-PD-Mini	-	92159
IR-PD-1C	-	92520
IR-PD-1C-E	-	92077
IR-Adapter for Smartphones	black	92726

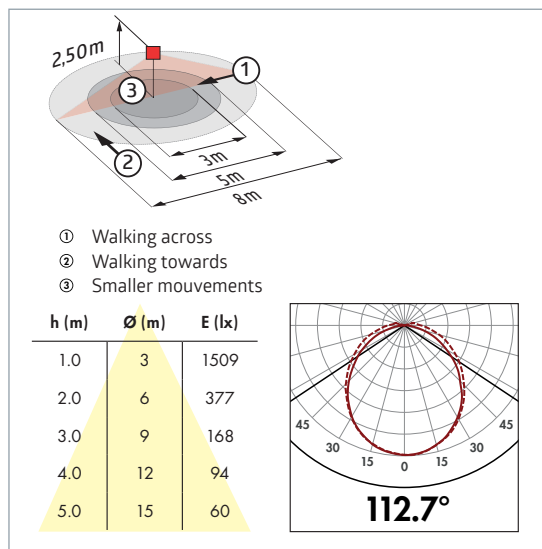
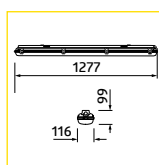

### Product information

- LED light for moisture-proof applications with integrated PIR occupancy detector
- Stainless steel clips make the light easy to open
- Wall or ceiling mounting - attach to supplied metal bracket or use screws through the case
- Good energy efficiency and long life using premium-quality LED technology
- Good heatsink capability via solid aluminium mounting plate
- Broad light distribution using diffused light covers
- Mini occupancy detector included, power unit integrated into light
- Easy control using required remote control, manual switching possible via push buttons
- Blinds included, can be installed from outside the device
- Additional lights can be controlled simultaneously by the one occupancy detector

### Technical data

#### Light

- LED circuit board securely mounted
- Colour temperature: 4000 K neutral white
- Luminous flux of LED: 4400 lm
- Luminous flux of luminaire: 3900 lm
- Peak: 1509 cd
- Efficiency: 111 lm/W
- CRI 83.7 / TM30: 82.3
- 230 V AC +/- 10 % 50 / 60 Hz
- 35 W / PF 0.94
- IP65 / Class I
- IK06 (1,0 Joule)
- 20 °C to +40 °C
- Shock-resistant polycarbonate case.
- LED circuit board on aluminum mounting plate
- Cover: PMMA diffuser, white
- 1277 x 116 x 99 mm
- Photobiological safety RG0

#### Occupancy detector

- 2300 W, cos phi = 1
- 1150 VA, cos phi = 0.5
- vertical
- max. Ø 8 m across
- max. Ø 5 m towards
- max. Ø 3 m smaller movements
- 10 - 2000 Lux
- 5 min - 30 min, pulse
- IR-Adapter for Smartphones, IR-PD-1C, IR-PD-Mini

## Product and accessory

Description	Colour	Part number
Moisture-Proof light AL60-LEDN-HF	grey	91747
Moisture-Proof light AL60-LEDN without motion detector	grey	91746

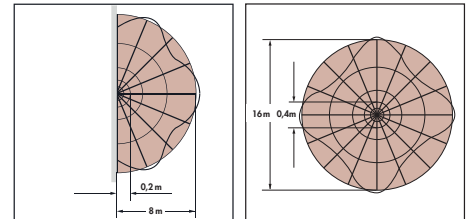
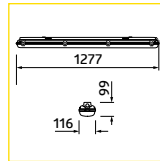

① Walking across or towards. The range depends on size and speed of the object.

h (m)	Ø (m)	E (lx)
1.0	3	1509
2.0	6	377
3.0	9	168
4.0	12	94
5.0	15	60

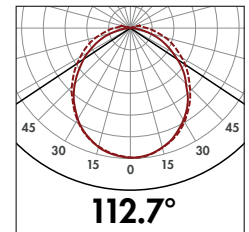

## Product information

- LED light for moisture-proof applications with integrated microwave detector
- Stainless steel clips make the light easy to open
- Wall or ceiling mounting - attach to supplied metal bracket or use screws through the case
- Good energy efficiency and long life using premium-quality LED technology
- Good heatsink capability via solid aluminium mounting plate
- Broad light distribution using diffused light covers
- Adjustments via potentiometers at the microwave detector
- Additional lights can be controlled simultaneously by the one microwave detector

## Technical data

### Light

LED circuit board securely mounted  
 Colour temperature: 4000 K neutral white  
 Luminous flux of LED: 4400 lm  
 Luminous flux of luminaire: 3900 lm  
 Peak: 1509 cd  
 Efficiency: 111 lm/W

CRI: 83.7 / TM30: 82.3  
 230 V AC +/- 10 % 50 / 60 Hz

35 W / PF 0.94

IP65 / Class I

IK06 (1.0 Joule)

-20 °C to +40 °C

Shock-resistant polycarbonate case. LED circuit board on aluminum mounting plate  
 Cover: PMMA diffuser, white

1277 x 116 x 99 mm

Photobiological safety RGO

### Microwave detector

1200 W, cos phi = 1  
 600 VA, cos phi = 0.5

vertical 360°

5.8 GHz, <10 mW

Ø 0.4 - 16 m

10 - 2000 Lux

5 s - 15 min



DT32/6/3SC-LED part no. 1207  
DT32/6/3DALI-LED part no. 1210

2DN14/6/3SC-LED part no. 1200  
2DN14/6/3DALI-LED part no. 1201  
2DN32/6/3SC-LED part no. 1206  
2DN32/6/3DALI-LED part no. 1215

### Series Diamant DT32 LED and Classic-2DN LED

Intelligent emergency lights  
with LED technic

- LED escape sign luminaire with single battery
- Bidirectional remote control with B.E.G. smartphone app
- Automatic self-test with two coloured status LEDs
- Optionally with central monitoring B.E.G. DALISYS



DATA CONTROL N part no. 93805





# Remote controls

## The B.E.G. IR-adapter for smartphones, the universal alternative to B.E.G. remote controls

Almost 15 years ago, B.E.G. was the first to offer a remote control-capable motion detector. Nowadays, almost all B.E.G. occupancy and motion detectors are remote control-capable. To make things easier, B.E.G. offers the remote control app.

What you need is a compatible Smartphone with internet connection and the B.E.G. LUXOMAT® remote control app, which is downloadable in the Google Play Store or the Apple Store. The update service ensures that the app is always up to date.

The app contains all current B.E.G. remote controls and therefore replaces more than 40 remote controls. The userfriendly navigation offers the possibility to search for the product to program or the respective remote control by name or part number. Therefore, the installer (or the user) quickly finds the right user interface.

The required B.E.G. IR-Adapter for Smartphones is simply plugged into the audio jack of the smartphone and establishes the communication with the respective detector. The battery is environmentally friendly thanks to being rechargeable and is charged via USB cable.

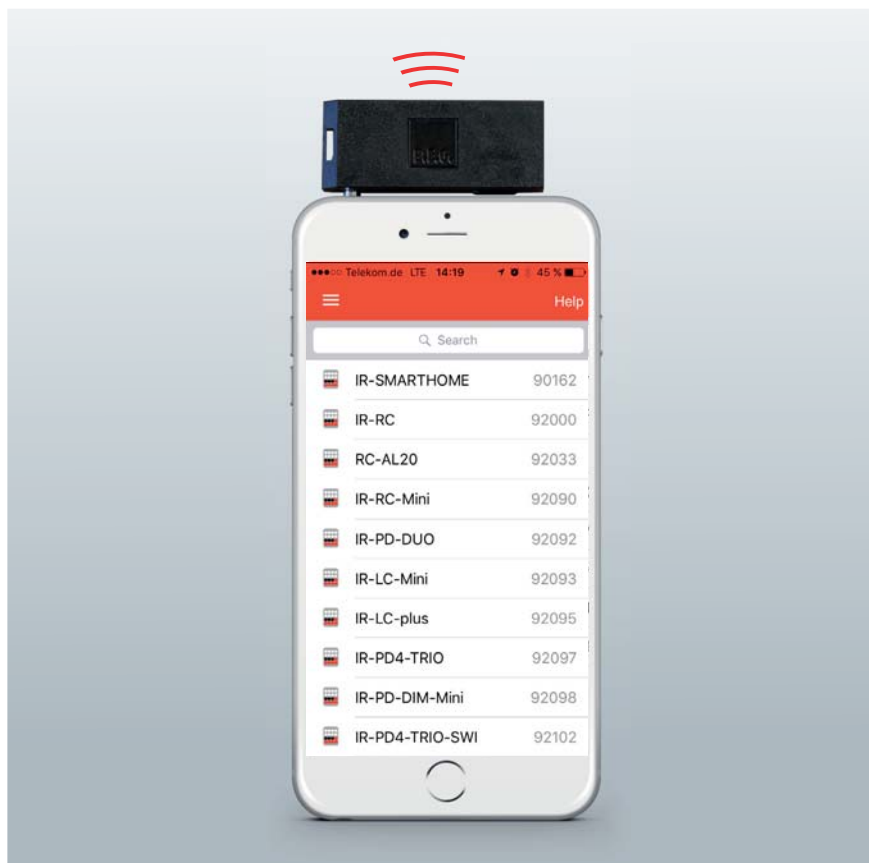

## Remote controls



### IR-Adapter for Smartphones

- Suitable for all lights and floodlights with integrated receiver diode

Description	Colour	Part number
IR-Adapter für Smartphones	black	92726

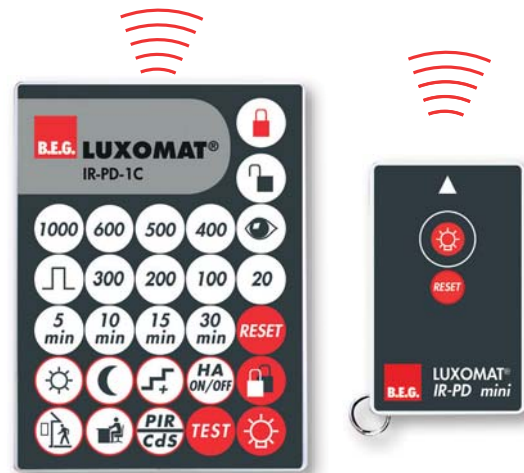

### IR-PD-1C / IR-PD-Mini

- Suitable for AL60-LEDN-PD9M

Description	Colour	Part number
IR-PD-1C	-	92520
IR-PD-Mini	-	92159



### IR-RC / IR-RC-Mini

- Suitable for FL2N-LED-230

Description	Colour	Part number
IR-RC	-	92000
IR-RC-Mini	-	92090



## PRODUCT LISTING

Part No.	Description	Prod./Gr.	Page	Part No.	Description	Prod./Gr.	Page
10880	RC-Arc extinction kit	06	44	92627	FL2N-LED-230 white	03	46
10882	Mini-RC-Arc extinction kit	06	44	92628	FL3N-LED-130 black	03	47
37849	Sealing ring IP54 HF-L1	06	37	92629	FL3N-LED-130 white	03	47
38003	Sealing ring FL2N	06	46	92702	FL3N-LED black	03	47
38004	Sealing ring FL3N	06	47	92703	FL3N-LED white	03	47
38140	Outer ring white	28	26	92726	IR-Adapter for Smartphones	09	56
38141	Outer ring aluminium-white	28	26	93014	AL8-protection ring	06	30
38142	Outer ring yellow	28	26	93066	PL1-30120-LED-AG-DALI-TW	29	21
38143	Outer ring red	28	26	93077	PL1-31125-LED-AG-DALI-TW	29	20
38144	Outer ring anthracite	28	26	93084	PL1-600-LED-AG-DALI-TW	29	19
38157	LED lamp E27 -10W / E27 (replaces conventional 60W bulb), Energy efficiency class A+	06	35	93090	Suspension cable set PL1-LED canopy	06	23
38158	Energy-saving lamp E27 - 15W (replaces conventional 60W bulb), Energy-class A	06	35	93094	PL1-625-LED-AG-DALI-TW	29	18
91301	ALC-B-360 SLU white	02	48	93098	DL10-18-172-LED-3C	28	40
91305	ALC-ES corner socket white	06	48	93099	Ceiling mounting frame for Module 600	06	23
91306	ALC-K-360 white	02	48	93115	Securing wires 1000 mm	06	23
91321	ALC-B-360 SLU black	02	48	93117	Mounting bracket set 4 pieces	06	23
91325	ALC-ES corner socket black	06	48	93128	DL11-18-172-LED-3C	28	41
91326	ALC-K-360 black	02	48	93141	AL8-25-300-LEDN-3C-HF	28	32
91400	AL1 130 white	02	50	93145	AL12-25-300-LEDN-3C-HF	28	34
91401	AL1 130 brown	02	50	93151	PL1-600-LED-AG-DALI-TW-S	29	19
91402	AL1 130 black	02	50	93168	DL12-18-172-LED-3C	28	42
91733	AL22-LEDN-HFR, without design ring white	28	27	93173	Pendulum set 1000 mm with 4 ceiling mountings	06	23
91743	AL22-LEDN, without design ring white	28	27	93181	Ceiling mounting frame for 625 mm modular systems	06	23
91744	AL22-LEDW, without design ring white	28	27	93615	AL12-25-300-LED-3C	28	33
91746	AL60-LEDN	02	52	93621	AL8-25-300-LEDN-3C	28	31
91747	AL60-LEDN-HF	02	53	93631	AL8-25-300-LEDN-HF	28	30
91751	AL60-LEDN-PD9M	02	52	93667	PL2-30120D-LED-AG-DALI-TW	29	22
92000	IR-RC	09	56	93681	PL1-625-LED-DALI-TW-S	29	
92077	IR-PD-1C-E	09	52	94055	PD2N-M-1C-LED-FC	13	44
92090	IR-RC-Mini	09	56	94100	SG Kristall - transparent	11	49
92159	IR-PD-Mini	09	56	94101	SG Oslo - transparent	11	49
92520	IR-PD-1C	09	56	94111	SG Paris - transparent/white	11	49
92598	FL2N-LED black	03	46	94113	SG Wien - white	11	49
92599	FL2N-LED white	03	46	94115	Spare glass for ALC-K	11	48
92626	FL2N-LED-230 black	03	46	94440	HF-L1	28	37
				94445	HF-L8	28	35

## PRODUCT LISTING

Part No.	Description	Prod./Gr.	Page
94446	L8	28	35
94447	HF-L11	28	36
94448	L11	28	36
94450	HF-L7	28	35
94451	L7	28	35
94453	L1	28	37
94455	L8-LEDN-HF	28	28
94456	L8-LEDN	28	28
94457	L9-LEDN-HF	28	29
94458	L9-LEDN	28	29





■ Subsidiaries and commercial agencies