



OPERATING INSTRUCTION DEFENSOR

- MD 200°
- MD 230°
- MD 280°

Version	Date	Comment
MA01708100	14/04/2020	First edition

© ESYLUX GmbH
An der Strusbek 40, 22926 Ahrensburg, Germany

Details may be subject to change.

Copying is only permitted with the written consent of ESYLUX GmbH. This includes translation into other languages and reuse of content for other purposes.

Table of contents

1. Information about the document	5
1.1 Introduction	5
1.2 Highlighted information within the text.....	5
1.3 Manufacturer address	6
1.4 Product identification	6
1.5 Warnings.....	7
2. Basic safety information	8
2.1 Safety instructions	8
2.2 Intended use	8
2.3 Liability and damages.....	9
3. Product description	9
3.1 Introduction	9
3.2 Included in delivery.....	10
3.3 Settings – an overview	11
3.4 Mechanical set-up.....	12
3.5 Rating label.....	13
3.6 Dimension drawing.....	13
3.7 Fields of detection	14
4. Installation and connection	16
4.1 Installation	16
4.2 Connection.....	20
4.2.1 Standard operation	21
4.2.2 Standard operation with additional control using a push button.....	21
4.2.3 Parallel connection	21
5. Initial operation	22
5.1 Warm-up phase	22
5.2 Default settings	22
6. ESY Control app and ESY-Pen	23
6.1 Operating principle.....	23
6.2 ESY Control app	24
6.3 Connecting the ESY-Pen to the ESY Control app	25

7. Settings with the ESY Control app	26
7.1 Temporary settings.....	26
7.1.1 Light on / off	26
7.1.2 4 h / 12 h light on / off	27
7.1.3 Reset to automatic mode	28
7.2 Permanent settings	28
7.2.1 Set time and date	28
7.2.2 360 degree crawl protection on / off.....	29
7.2.3 Operating mode	29
7.2.4 Brightness switching value.....	33
7.2.5 Switch-off delay time.....	34
7.2.6 Motion sensor sensitivity	35
7.2.7 Detector LED on / off.....	36
7.2.8 Reset to default settings	37
7.2.9 Test mode	37
7.2.10 Password protection	37
8. Manual control via push button	38
9. Maintenance	40
9.1 Cleaning	40
9.2 Troubleshooting	40
10. Technical data	41
11. Disposal	44
12. EU Declaration of Conformity	44
13. ESYLUX manufacturer's guarantee	44



1. Information about the document

1.1 Introduction

These operating instructions contain detailed information about the installation, commissioning and configuration of the specified devices. This document is available online on the relevant product web page at www.esylux.com and can be printed out in A4 format. Please read the operating instructions carefully and note all safety information and warnings.

Navigating on screen

When you are reading the document on screen, you can use the following functions:

- **Linked table of contents:** Clicking on the chapter title opens the corresponding chapter.
- **Linked references:** You can navigate to specified locations by clicking on the → *link* .
- **List of bookmarks:** All chapters can be accessed from the list of bookmarks  in the software you use to view PDF files.

1.2 Highlighted information within the text

Formatting

To make these operating instructions easier to read, certain information is highlighted by different means. The meaning of this formatting is explained below:

- indicates a call for action
- ✓ indicates results of actions
- < > indicates menu items of the app
- *indicates text links*



indicates important and useful information



warns of high voltage

1.3 Manufacturer address

ESYLUX GmbH
 An der Strusbek 40
 22926 Ahrensburg | Germany
 info@esylux.com
 www.esylux.com

1.4 Product identification

These instructions apply to the following products:

Item number	Product name
EM10025358	DEFENSOR MD 200° 24 IR 1C IP55 WH
EM10025365	DEFENSOR MD 200° 24 IR 1C IP55 AN
EM10025372	DEFENSOR MD 230° 40 IR 1C IP55 WH
EM10025389	DEFENSOR MD 230° 40 IR 1C IP55 AN
EM10025396	DEFENSOR MD 280° 40 IR 1C IP55 WH
EM10025402	DEFENSOR MD 280° 40 IR 1C IP55 AN

You can find the item number and product name on the type plate of the products in chapter → ["3.5 Rating label" on page 13](#).

The product name contains important information about the product:

Elements	Meaning
DEFENSOR	Series
MD	Motion detectors
200° / 230° / 280°	Sensing range
24 / 40	Field of detection width in metres Ø
IR	Remote controllable (infrared)
1C	1 light channel
IP55	Protection type
WH	White (housing colour)
AN	Anthracite grey (housing colour)

1.5 Warnings

Warnings are listed at the start of the relevant chapter if a hazardous situation is likely to occur.

The preceding signal words have the following meanings:

 **DANGER!**

This signal word denotes a hazard involving a high level of risk. Failure to observe the warning will lead to serious or fatal injury.

 **WARNING!**

This signal word denotes a hazard involving a moderate level of risk. Failure to observe the warning may lead to serious or fatal injury.

 **CAUTION!**

This signal word denotes a hazard involving a low level of risk. Failure to observe the warning may lead to minor or moderate injury.

NOTE!

This signal word warns against situations that could lead to instances of property damage if the information is not observed.

2. Basic safety information

2.1 Safety instructions

Specialist personnel

Electrical devices connected to a 230-V mains voltage must only be installed and commissioned by electrical installation technicians or trained electricians, taking country specific regulations into account.

**DANGER!****Risk of fatal injury from electric shock!**

- The following five safety rules must always be observed:
 1. Disconnect the power supply
 2. Secure the power supply from being switched on again
 3. Check that the relevant components have been de-energised
 4. Set up the earthing and short-circuiting mechanisms as required
 5. Cover or isolate neighbouring live parts
- Protect the device with a 10-A circuit breaker.
- Protect the circuit with a residual current device (RCD).
- Observe the contact opening width ($\mu = < 1.2 \text{ mm}$).

2.2 Intended use

Place of use

The motion detectors from the DEFENSOR series are designed for use in outdoor areas and use passive infrared technology (PIR). They react to moving heat sources (persons, vehicles) and are suitable for use around the home, and in gardens, garages or carports.

The MD 200° is designed for wall mounting, while the MD 230° and MD 280° variants can also be mounted on the ceiling. Surface mounting or mounting on inner / outer corners is possible with the appropriate accessories.

2.3 Liability and damages

The device must not be changed, modified or painted – doing so will void any warranty claims.

The manufacturer will not accept any liability for instances of personal injury or property damage caused by improper use.

Check the product for damage after unpacking. If the device is damaged in any way, return it to the relevant place of sale.

3. Product description

3.1 Introduction

The motion detector automatically controls the lighting based on motion and ambient light conditions. If the motion detector detects movement within its field of detection, it switches on the connected lighting for an adjustable period of time in accordance with the configured brightness switching value.

Properties

Main product features:

- Sensing range of 200°, 230° or 280°
- Detection range width of 24 m / 40 m in diameter at an installation height of 3 m
- The detector is supplied with the default settings / fully automatic mode
- With zero-cross switching for load-free switching of the connected devices

Product description

Overview of features

The following table shows an overview of the functions of the devices:

Functions	MD 200°	MD 230° MD 280°
Time-dependent operating modes		•
Intelligent vandalism and sabotage protection		•
Crawl protection for unbroken coverage		•
Switch-off delay times based on motion direction detection		•
Customisable fields of detection	•	•
Impulse feature	•	•
Integrated push button input	•	•
Zero-cross switching to protect the relay	•	•
Password-protected parameterisation	•	•
High overvoltage protection	•	•
Configurable via the ESY Control app and ESY-Pen	•	•

3.2 Included in delivery

1 x motion detector
1 x lens mask
1 x short instruction

Accessories

Optional accessories:
ESY-Pen (item no. EP10425356)
Spacer (item no. EM10025426)
Corner bracket (item no. EM10025419)

3.3 Settings – an overview

Operation via
ESY Control app
with ESY-Pen

The motion detector has no setting elements. All settings can only be modified using the ESY Control app and the ESY-Pen.

Settings	Description
<i>Light on / off</i>	Used to manually switch lighting on or off regardless of movement and ambient light conditions
<i>4 h / 12 h light on / off</i>	Used to manually switch lighting on or off for 4 hours or 12 hours regardless of movement and ambient light conditions
<i>Reset to automatic mode</i>	Used to reset temporary settings
<i>Set time and date</i>	Used to set the date and time in order to use time-dependent functions
<i>360 degree crawl protection on / off</i>	Used to switch the field of detection directly underneath the motion detector on or off
<i>Operating mode fully automatic</i>	Enables automatic light control in the event of detected movement
<i>Operating mode semi-automatic</i>	Enables automatic light control in the event of detected movement once activated manually using an external push button
<i>Operating mode twilight switch</i>	Enables motion-independent light control on the basis of the brightness switching value
<i>Operating mode light on / off</i>	Used to manually switch lighting on or off regardless of movement and ambient light conditions
<i>Brightness switching value</i>	The lighting is automatically controlled on the basis of the configured brightness switching value
<i>Switch-off delay time</i>	Used to configure how long the lighting remains switched on after movement is detected
<i>Motion sensor sensitivity</i>	Used to adjust the sensitivity and range of motion detection
<i>Detector LED on / off</i>	Used to switch the illumination of the detector LED as a form of feedback on or off

Settings	Description
<i>Reset to default settings</i>	Used to reset the motion detector to default settings
<i>Test mode</i>	Used to test the fields of detection of the motion detector
<i>Password protection</i>	Used to set a password to protect against unauthorised access

You can find a comprehensive description of the possible settings in chapter → ["7. Settings with the ESY Control app" on page 26.](#)

3.4 Mechanical set-up

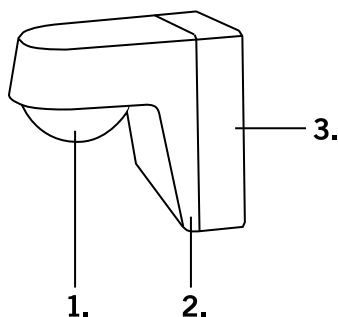

MD 200°

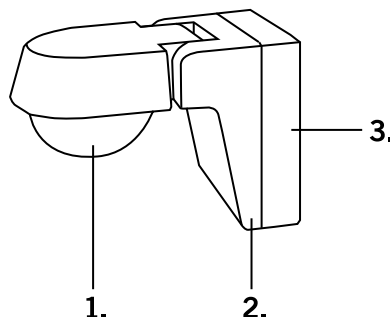

MD 230° / MD 280°

1. Sensor
2. Sensor unit
3. Mounting base

3.5 Rating label

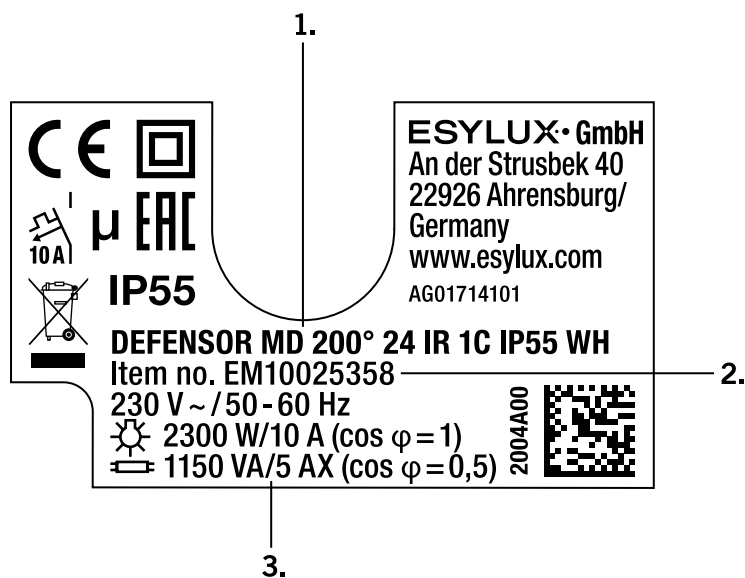

1. Product name
2. Item number
3. Technical data

3.6 Dimension drawing

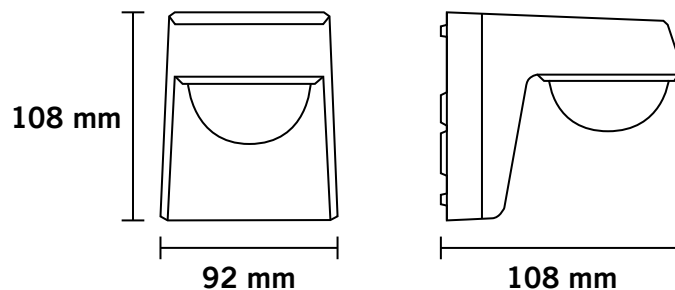

MD 200°

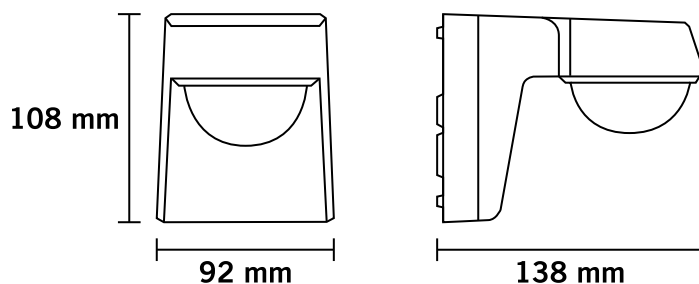

MD 230° / MD 280°

3.7 Fields of detection

The motion detector is most sensitive to crosswise movements and detects these up to the specified maximum range. There is a reduced range for the reliable detection of movements that are head-on to the detector.

The greater the installation height, the larger the detection range, but the lower the sensitivity. The specified fields of detection apply for an ambient temperature of approx. 25 °C.

- Detection angle 200° / 230° / 280°
- Installation height 3 m (max. 5 m for MD 200°, max. 6 m for MD 230° / MD 280°)

MD 200°	∅ m	
Diagonally (A)	24	<p>The diagram illustrates the 200-degree detection field of the motion detector. It shows a semi-circular area divided into two parts: a shaded outer region labeled 'A' (Diagonally) and a white inner region labeled 'B' (Head-on). The total angle of the field is marked as 200°. Arrows 'A' and 'B' point to their respective regions.</p>
Head-on (B)	8	

Product description

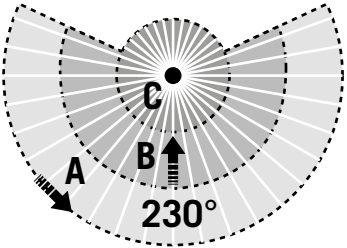
MD 230°	∅ m	
Diagonally (A)	40	
Head-on (B)	10	
Crawl protection (C)	4	

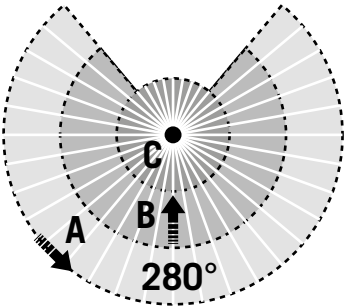
MD 280°	∅ m	
Diagonally (A)	40	
Head-on (B)	10	
Crawl protection (C)	4	

4. Installation and connection

4.1 Installation

Installation type / location

The motion detector is designed for wall and ceiling mounting (ceiling mounting only suitable for MD 230° / MD 280°). The motion detector must be mounted on a solid, even surface (wall / ceiling). Surface mounting or mounting on inner / outer corners is possible with the appropriate accessories.

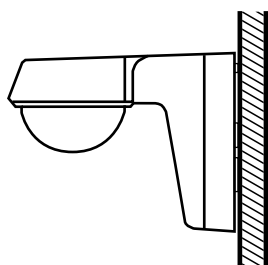

Wall mounting

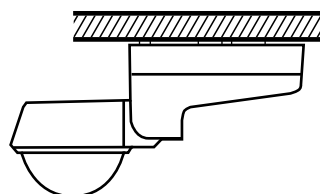

Ceiling mounting (MD 230° / MD 280°)

The following installation types are possible with accessories:

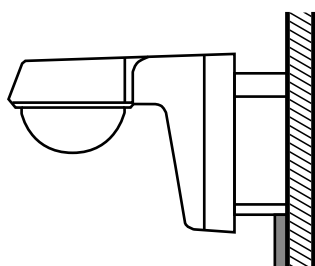

Wall mounting with spacers in the case of surface-mounted cabling

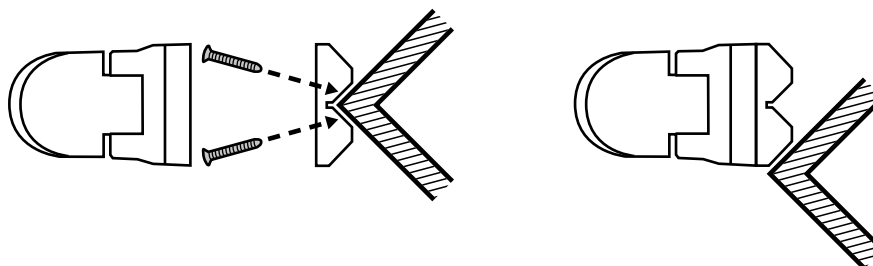

Mounting on outer corners with a corner bracket

NOTE!

In order to prevent chipping due to bore holes that are at too much of an angle, observe the positioning of the screws.

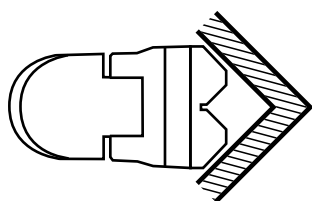

Mounting on inner corners with a corner bracket

Installation instructions:

- Position the motion detector in a location that is appropriate for the spatial conditions and requirements.
- When installing the device, consider the surrounding area, e.g. neighbouring properties and the distance to the road.
- Ensure connected lighting is mounted with sufficient clearance from the motion detector or is mounted above it to avoid any interference with the light sensor.
- Do not point light sources directly at the motion detector



When selecting an installation location, make sure that the motion detector has a clear line of sight, as infrared beams cannot penetrate solid objects.

**DANGER!****Risk of fatal injury from electric shock!**

- Switch of the mains voltage before installing / removing the detector.
- Check that the mains voltage is de-energised.

Installation steps:

- Disconnect the sensor unit from the mounting bracket. These are connected via a plug-in connection.
- Feed the cable into the detector and install the mounting base in the required position.



The distances between the screw holes **A** are compatible with those of the RC series of outdoor motion detectors from ESYLUX. The distances between the screw holes **B** are suitable for conventional recessed boxes (60 mm).

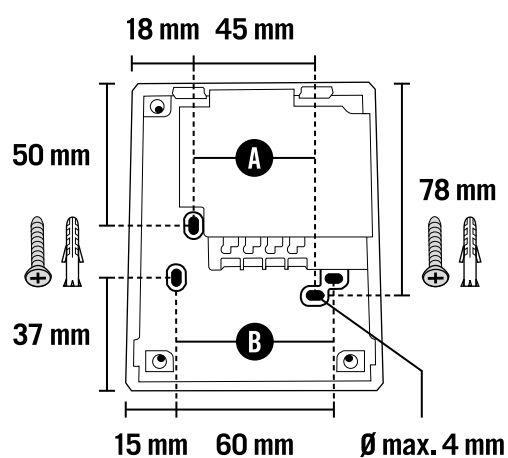

After connecting the motion detector:

- Connect the cables between the sensor unit and the mounting base.

i When connecting the cables, ensure that the red wire is at the top.

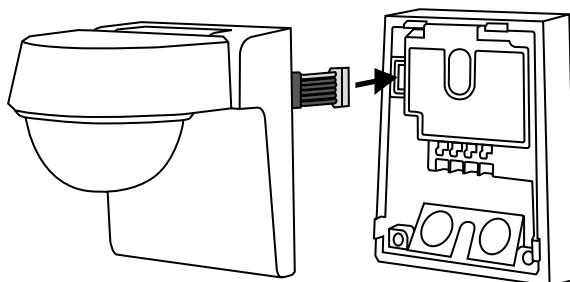

Connecting the sensor unit and mounting base:

- Press the sensor unit onto the mounting base.
- ✓ A "click" noise at the top and bottom confirms that they have been properly fixed together.
- Then tighten the screws.

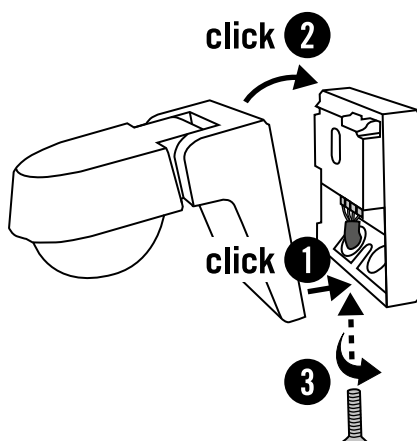

- Adjust the motion detector to the spatial conditions by horizontally or vertically aligning the moveable lens (MD 200°) or the sensor head (MD 230° / MD 280°).

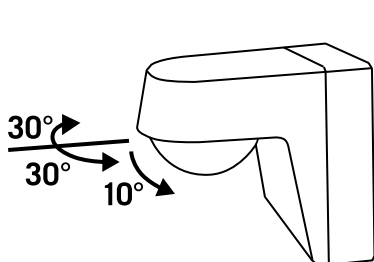

MD 200°

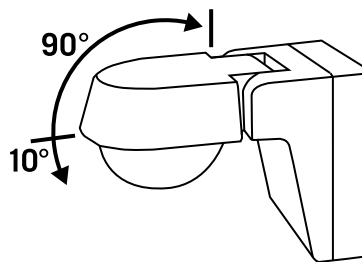

MD 230° / MD 280°

The field of detection of the motion detector can also be regulated mechanically using the supplied lens mask. You can find other settings to adjust the field of detection in chapter → ["7.2.6 Motion sensor sensitivity" on page 35](#).

4.2 Connection



DANGER!



Risk of fatal injury from electric shock!

- Switch of the mains voltage before connecting the product.
- Check that the mains voltage is de-energised.

Proceed as follows to connect the motion detector:

- Observe the following circuit diagrams and terminal assignments.

**Terminal
assignment**

L	External conductor, 230 V~
L'	Switched external conductor 230 V~
N	Neutral conductor
S	Push button

A separate terminal is also available to loop through or fix the earth conductor.



Earth conductor

4.2.1 Standard operation

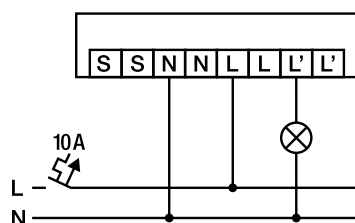

4.2.2 Standard operation with additional control using a push button

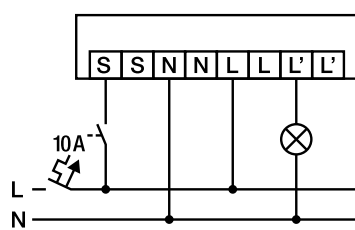

You can find a comprehensive description of this in chapter → ["8. Manual control via push button" on page 38.](#)

4.2.3 Parallel connection

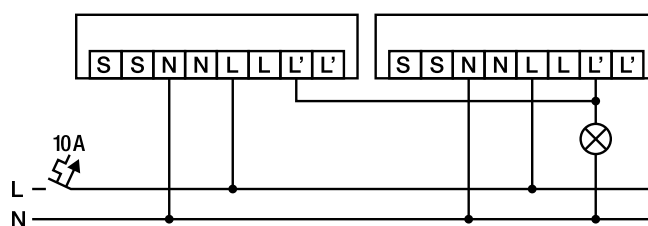

Up to 10 motion detectors can be connected in parallel.

5. Initial operation

5.1 Warm-up phase

The motion detector initiates a warm-up phase each time the mains voltage is connected.

Warm-up phase

- Connect the mains voltage.
- ✓ A warm-up phase of approx. 45 seconds is initiated.
- ✓ During this time, the lighting is switched on.
- ✓ When the motion detector is commissioned for the first time, the detector LED flashes blue – red – red alternately.
- ✓ The warm-up phase is over when the green detector LED briefly flashes three times after this and the lighting switches off again.

i If individual settings have already been configured on the motion detector, the detector LED flashes blue – red alternately during the warm-up phase.

5.2 Default settings

The motion detector is equipped with default settings. It is ready for operation after the warm-up phase and operates in accordance with the default settings.

Default settings:

MD 200°

Operating mode	Fully automatic
Brightness switching value	20 lx
Switch-off delay time	5 min.
Motion sensor sensitivity	100 %
Detector LED	On
Test mode	Off
Password	0000

MD 230° / MD 280°

Operating mode	Fully automatic
Brightness switching value	20 lx
Switch-off delay time	5 min.
Motion sensor sensitivity	100 %
Detector LED	On
Test mode	Off
Crawl protection	On
Time and date	not defined
Automatic adjustment of the clock to summer / winter time	On
Password	0000

The settings can be re-configured or customised at any time using the ESY Control app via the ESY-Pen; see chapter → ["7. Settings with the ESY Control app" on page 26.](#)

The MD 230° / MD 280° devices feature intelligent vandalism and sabotage protection. If the sensor head is subjected to any forceful impact, the lighting stays switched on permanently.

All of the motion detectors from the DEFENSOR series are also equipped with overvoltage protection to prevent irreparable damage due to lightning strikes or temporary overloading of power supply systems (surge 2 kV, burst 4 kV).

6. ESY Control app and ESY-Pen

6.1 Operating principle

Parametrisation

Parameters can only be configured using the ESY Control app with the ESY-Pen (item no. EP10425356).

First, the parameters are changed in the ESY Control app. Then the ESY-Pen serves as a bridge to transmit the Bluetooth commands from the mobile device to the motion detector using infrared technology.

As the infrared interface is located in the head of the ESY-Pen, the following must be taken into account with regards to communication between the ESY-Pen and the motion detector:

- When programming, always direct the head of the ESY-Pen towards the motion detector.

i Direct sunlight can reduce the standard range of approx. 8 m. This is due to the effect of the sun's infrared radiation

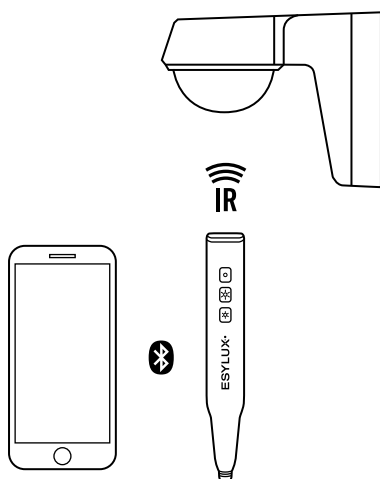

Communication: smartphone – ESY-Pen – motion detector

i It is not possible to transfer parameters from the motion detector into the ESY Control app. The communication between the ESY-Pen and the motion detector is unidirectional.

6.2 ESY Control app

The free ESY Control app is available in the Google Play Store and Apple App Store for the following mobile devices:

- Apple devices with operating system iOS 11 or above
- Android devices with Android version 6.0 or above

- Scan the QR code to download the ESY Control app.







Proceed as follows to add your product:

- Start the ESY Control app.
- Press the button **< Select products and configure >**.
- Press the button **< Add product >** and select your product using the search function or by scanning the bar code on your product.
- ✓ Your product appears in the product list.
- ✓ Parameters can be configured.

You need the ESY-Pen to transfer the modified parameters to the device.

6.3 Connecting the ESY-Pen to the ESY Control app

1. Switch on the ESY-Pen.

- Press the **< On / Off button  >** for two seconds.
- ✓ The **< On / Off button  >** lights up red.
- ✓ Both **< function buttons  +  >** will light up white when the mobile device is switched on.

2. Activate Bluetooth® on your mobile device.

3. Start the ESY Control app.

- In the dashboard, press the **< No connection >** button at the bottom.
- Select your ESY-Pen **< ESY-Pen Vx.x xxxx >** from the list.

- Enter the security pin when requested.
- ✓ After it has been successfully connected, your **< ESY-Pen Vx.x xxxx >** will be listed at the bottom of the dashboard.
- ✓ The ESY-Pen is now ready for use.



If no ESY-Pen (ESY-Pen Vx.x xxxx) is listed, swipe down to update the list. You can find the name and security pin of your ESY-Pen on the identification label on the device.

7. Settings with the ESY Control app

The motion detector features a detector LED behind the lens, which provides information about the status of the device. The colours of the detector LED have the following meanings:

Green	Setting / configuration modified
Blue	Programming mode
Red	Motion detection, warm-up phase, incorrect password entered
Violet	Infrared signal transmission
Turquoise	Test mode

7.1 Temporary settings

User

You can configure temporary settings under the **< User >** menu item.

7.1.1 Light on / off

The lighting is switched on or off regardless of movement and ambient light conditions

The motion detector switches the lighting **on or off** until ...

- it detects a movement
- and**
- until the configured switch-off delay time has elapsed

Once this time has elapsed, the motion detector switches back to the configured operating mode. You can cancel this setting by activating the **< Reset to automatic mode >** setting.

Setting options: **< On > < Off >**

Acknowledgement: The lighting switches on or off. The violet detector LED flashes once to indicate that the infrared signal has been successfully received.

7.1.2 4 h / 12 h light on / off

The lighting is switched on or off for four hours or twelve hours regardless of movement and ambient light conditions.

Once the four hours or twelve hours have elapsed, the detector switches back to the configured operating mode.

 When this setting is activated, the motion detector no longer reacts to movement and does not take the brightness switching value into account.

You can cancel this setting by activating the **< Reset to automatic mode >** setting.

Setting options: **< 4 h light on > < 4 h light off > < 12 h light on > < 12 h light off >**

Acknowledgement: The lighting switches on or off for four hours or twelve hours. The violet detector LED flashes once to indicate that the infrared signal has been successfully received.

7.1.3 Reset to automatic mode

This setting clears all temporary settings. The motion detector returns to the configured operating mode.

Acknowledgement: The lighting switches on. After the changes have been completed, the violet detector LED flashes once to indicate that the infrared signal has been successfully received. The lighting then switches off.

7.2 Permanent settings

Advanced

You can configure permanent settings under the **< Advanced >** menu item. You can also compile a list of settings that have been made and send these in a single step.



In the event of a power failure, the password becomes invalid within approximately one minute. The other settings are saved for up to one week. After this, the motion detector operates according to the default settings.

7.2.1 Set time and date

With the MD 230° / MD 280° models, you can either set the time and date or copy the time and date from your smartphone.

Setting options: **< Time >** **< Date >** **< Copy time and date from smartphone >**

The setting for automatic adjustment of the clock to summer / winter time can also be activated / deactivated.

Setting options: **< On >** **< Off >**

Acknowledgement: The lighting switches on. The detector LED provides various feedback signals during transmission. After the changes have been completed, the green detector LED flashes three times to confirm this. The lighting then switches off.

7.2.2 360 degree crawl protection on / off

The crawl protection function of the MD 230° / MD 280° devices ensures that the area directly underneath the motion detector is also detected.

Setting options: < On > < Off >

Acknowledgement: The lighting switches on. The detector LED provides various feedback signals during transmission. After the changes have been completed, the green detector LED flashes three times to confirm this. The lighting then switches off.

7.2.3 Operating mode

There is a choice of three different operating modes.

- Fully automatic
- Semi-automatic
- Twilight switch

Setting options: < Fully automatic > < Semi-automatic >
< Twilight switch >

Acknowledgement: The lighting switches on. The detector LED provides various feedback signals during transmission. After the changes have been completed, the green detector LED flashes three times to confirm this. The lighting then switches off.

Fully automatic

When < **Fully automatic** > operating mode is active, the lighting is controlled based on movement and the ambient light conditions.

Switching on automatically

The motion detector automatically switches **on** the lighting when ...

- it detects a movement
- and**
- the level of ambient light is below the configured brightness switching value

Every additional movement is indicated by a single brief flash of the red detector LED and the switch-off delay time is restarted. The detector LED can be switched off; see chapter → ["7.2.7 Detector LED on / off" on page 36](#).

Switching off automatically

The motion detector automatically switches **off** the lighting when ...

- it does not detect any movement
- or**
- the level of ambient light is above the configured brightness switching value
- and**
- the configured switch-off delay time has elapsed

The fully automatic operating mode can be overridden at any point using the ESY Control app and the ESY-Pen. The fully automatic operating mode switches off the lighting when no movement is detected and the configured switch-off delay time has elapsed.

Semi-automatic

When the **< Semi-automatic >** operating mode is active, the lighting must always be switched on manually via an external push button or via the **< Light on >** setting in the ESY Control app. After this, the lighting is controlled based on movement and the ambient light conditions, as is the case in fully automatic operating mode.

Switching on manually

The motion detector automatically switches **on** the lighting when ...

- an external push button is actuated.

Switching off automatically

The motion detector automatically switches **off** the lighting when ...

- it does not detect any movement
- or**
- the level of ambient light is above the configured brightness switching value
- and**
- the configured switch-off delay time has elapsed

When the motion detector switches off the lighting as a result of the brightness switching value being exceeded, it must then be re-activated using an external push button or with the ESY Control app and the ESY-Pen – even if there is movement.

Semi-automatic operating mode can be overridden at any point using the ESY Control app and the ESY-Pen. Semi-automatic operating mode switches off the lighting when no movement is detected and the configured switch-off delay time has elapsed.

Twilight switch

When **< Twilight switch >** operating mode is active, the lighting is controlled based exclusively on the brightness switching value.

The motion detector ignores any detected movement.

You can find information on setting the brightness switching value and accepting the current light value in chapter → ["7.2.4 Brightness switching value" on page 33](#).

Switching on automatically

The motion detector automatically switches **on** the lighting when ...

- the level of ambient light is below the configured brightness switching value

Switching off automatically

The motion detector automatically switches **off** the lighting when ...

- the level of ambient light is above the configured brightness switching value

If the lighting is manually overridden via an external push button or via the **< Light on / off >** setting in the ESY Control app, the motion detector returns to normal operation when the ambient light value exceeds or drops below the brightness switching value again.

For the MD 230° / MD 280° devices, two time windows can be set within a 24-hour period in which they can deviate from the standard set operating mode.

The following options are available:

- Fully automatic (automatic light control in the event of detected movement)
- Semi-automatic (automatic light control in the event of detected movement, must be activated manually using an external push button)

- Twilight switch (motion-independent light control on the basis of the brightness switching value)
- Light on (switches lighting on permanently, regardless of movement and ambient light conditions)
- Light off (switches lighting off permanently, regardless of movement and ambient light conditions)



Ensure that the exception periods do not overlap.

Setting options: < Exception 1 > < Exception 2 >

Acknowledgement: The lighting switches on. The detector LED provides various feedback signals during transmission. After the changes have been completed, the green detector LED flashes three times to confirm this. The lighting then switches off.

Example:

Setting in the ESY Control app:

- Standard operating mode – Fully automatic
- Exception 1 – Twilight switch
from 9 am until 7 pm

In the application example, an MD 230 is used on the premises of a retail store in fully automatic operating mode. However, during opening hours the lighting should be switched on at all times whenever there is insufficient daylight, even if no motion is detected. The motion detector therefore operates in twilight switch mode between 9 am and 7 pm.

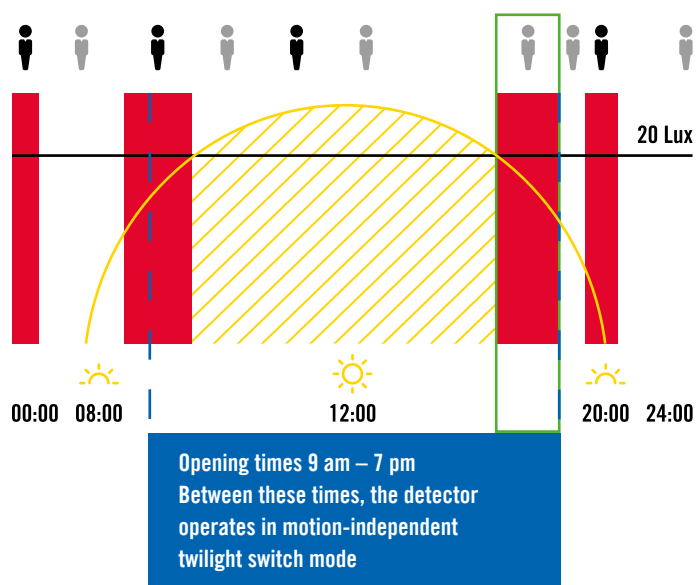

- Artificial light
- ▨ Sufficient natural light
- Present
- Absent

7.2.4 Brightness switching value

The **< brightness switching value >** is a threshold value for controlling the lighting.

The motion detector automatically switches **on** the lighting when ...

- it detects a movement
- and**
- the level of ambient light is below the configured brightness switching value

The motion detector automatically switches **off** the lighting when ...

- it does not detect any movement

or

- the level of ambient light is above the configured brightness switching value

and

- the configured switch-off delay time has elapsed

Setting options: < 2 - 2000 lx > < Accept current light value >

In the < **Accept current light value** > setting, you can read in the current light value as a brightness switching value. In this case, the motion detector measure the current light value and adopts this as the new brightness switching value.

Acknowledgement: The lighting switches on. The detector LED provides various feedback signals during transmission. After the changes have been completed, the green detector LED flashes three times to confirm this. The lighting then switches off.

7.2.5 Switch-off delay time

This setting determines how long the light remains switched on after the last detected movement. Each detected movement restarts the switch-off delay time.

The switch-off delay time is activated when ...

- the lighting is switched on due to movement
- the level of ambient light is below the brightness switching value
- the motion detector does not detect any further movement

Setting options: < Pulse > < 1 min - 240 min >

Acknowledgement: The lighting switches on. The detector LED provides various feedback signals during transmission. After the changes have been completed, the green detector LED flashes three times to confirm this. The lighting then switches off.

Pulse: When movement has been detected and the level of ambient light is below the configured brightness switching value, the red LED flashes once, the relay opens for one second and the closes again for nine seconds.

For the MD 230° / MD 280° devices, a switch-off delay time based on the direction of movement can be configured in addition to the standard switch-off delay time. With this setting, different switch-off delay times can be set depending on the direction of movement of the detected person. The following directions are available:

- Movement from left to right (from the perspective of the sensor)
- Movement from right to left (from the perspective of the sensor)
- Movement towards the sensor
- Movement away from the sensor

If a movement cannot be clearly categorised, because multiple people are in the field of detection, for example, the standard switch-off delay time is used.



Crawl protection must be activated in order to use the **< Depending on direction of movement >** setting.

Setting options: < 1 min - 240 min >

Acknowledgement: The lighting switches on. The detector LED provides various feedback signals during transmission. After the changes have been completed, the green detector LED flashes three times to confirm this. The lighting then switches off.

7.2.6 Motion sensor sensitivity

The motion detector is equipped with a highly sensitive passive infrared sensor. In this setting, you can adjust the general sensitivity of the sensor to limit the field of detection on an individual basis.

The field of detection of the motion detector can also be adjusted by **horizontally or vertically aligning** the moveable lens (MD 200°) or the sensor head (MD 230° / MD 280°). It can also be mechanically adjusted using the supplied lens mask.

Setting options: < Standard > < slightly reduced sensitivity >
< reduced sensitivity > < strongly reduced sensitivity >

Acknowledgement: The lighting switches on. The detector LED provides various feedback signals during transmission. After the changes have been completed, the green detector LED flashes three times to confirm this. The lighting then switches off.

For the MD 230° / MD 280° models, you can also limit the field of detection of specific segments individually and activate / deactivate crawl protection.

Setting options: < 0 % > < 25 % > < 50 % > < 75 % > < 100 % >

Acknowledgement: The lighting switches on. The detector LED provides various feedback signals during transmission. After the changes have been completed, the green detector LED flashes three times to confirm this. The lighting then switches off.

7.2.7 Detector LED on / off

The motion detector features a detector LED behind the lens, which provides information about the status of the device. The illumination of the detector LED as a form of LED feedback can be switched on or off in standard operating mode. However, this cannot be done during the configuration. The colours of the detector LED have the following meanings:

Green	Setting / configuration modified
Blue	Programming mode
Red	Motion detection, warm-up phase, incorrect password entered
Violet	Infrared signal transmission
Turquoise	Test mode

Setting options: < On > < Off >

Acknowledgement: The lighting switches on. The detector LED provides various feedback signals during transmission. After the changes have been completed, the green detector LED flashes three times to confirm this. The lighting then switches off.

7.2.8 Reset to default settings

This setting is used to reset all settings to the default settings. You can find the default settings in chapter → ["5.2 Default settings" on page 22](#).

Acknowledgement: The lighting switches on. The detector LED provides various feedback signals during transmission. After the changes have been completed, the green detector LED flashes three times to confirm this. The lighting then switches off.

7.2.9 Test mode

In **< Test mode >**, you can test the detector's motion detection function by walking through the field of detection. When test mode is activated, the motion detector only detects movement and ignores the ambient light conditions.

You can make required changes to the field of detection via the **< Motion sensor sensitivity >** setting (see chapter → ["7.2.6 Motion sensor sensitivity" on page 35](#)), mechanically using the supplied lens mask or by *horizontally or vertically aligning* the moveable lens (MD 200°) or the sensor head (MD 230° / MD 280°). When test mode is active, no settings can be configured.

Setting options: **< On > < Off >**

Acknowledgement: When test mode is active, the detector LED lights up in turquoise constantly, and when movement is detected this briefly flashes red. The switch-off delay time is two seconds. Then there is an idle period of four seconds. During this time, motion detection is switched off. Once test mode is no longer active, the green detector LED flashes three times to confirm this.

7.2.10 Password protection

A personal password can be set to prevent unauthorised parties from configuring the motion detector. The best way to use this setting is by configuring a "Project" in the ESY Control app. This is the only way to ensure that the new password is documented in a PDF report.

The motion detector has the password 0000 by default and is unprotected. A new password must be set to activate password protection. After a new

password is set, the motion detector locks automatically. You can unlock the motion detector again by entering the selected password.

To remove **< password protection >** again, enter the current password and then set 0000 as the new password. Alternatively, you can completely disconnect the device from the mains voltage for one minute.

Acknowledgement: The lighting switches on. After the change has been completed, the violet detector LED flashes four times to indicate that the infrared signal has been successfully received. The lighting then switches off. If the password is entered incorrectly or there is a transmission fault, the detector LED flashes violet – red – violet – violet.

8. Manual control via push button

The motion detector is equipped with a connection for an external push button (S terminal, for information on connection see chapter → ["4.2.2 Standard operation with additional control using a push button" on page 21](#)). This means that the motion detector can be manually overridden at any time so that the lighting can be switched on or off individually.

The motion detector switches the lighting **on or off** until ...

- it detects a movement
- or**
- until an external push button is pressed again
- and**
- until the configured switch-off delay time has elapsed

Once this time has elapsed, the motion detector switches back to the configured operating mode.

Manual control via push button

Switching on lighting manually

You can send the following temporary commands using the external push button:

- Briefly press (< 1 second) the push button once.
 - ✓ The lighting is switched on or off.

- Briefly press (< 1 second) the push button twice within 4 seconds.
 - ✓ The lighting is switched on or off for 4 hours continuously.

- Briefly press (< 1 second) the push button three times within 4 seconds.
 - ✓ The lighting is switched on or off for 12 hours continuously.

To cancel a temporary command, briefly press the push button once or select the following setting in the ESY Control app → **"7.1.3 Reset to automatic mode" on page 28**).

Example 1:

The lighting is switched on and the user wants to switch it off for the next 12 hours.

- Briefly press the push button three times within 4 seconds.

Example 2:

The lighting is switched off and the user wants it to remain switched off for the next 12 hours.

- Briefly press the push button once to switch on the lighting.

- Wait for longer than 4 seconds.

- Briefly press the push button once to switch off the lighting and press it again twice within 4 seconds to switch the lighting off continuously for 12 hours.

9. Maintenance

The device is maintenance-free. In the event of damage the entire device must be replaced.

9.1 Cleaning

WARNING!

Using the wrong cleaning products will damage the device. Do not use corrosive cleaning agents or solvents for cleaning and care of the device.

- Use a lint-free cloth that is either dry or dampened with water.

9.2 Troubleshooting

Fault	Cause
Motion detector is not starting up	<ul style="list-style-type: none"> - Check the cable connection between the sensor head and the mounting base. The red wire must be on top.
The lighting does not switch on automatically – despite movement	<ul style="list-style-type: none"> - The level of ambient light is above the configured brightness switching value - Lighting has been switched off manually - The people are outside the range of detection. - The motion detector does not have a clear line of sight. There are sources of interference such as shrubs or trees in the field of detection - The configured switch-off delay time is too short - Time-dependent operating modes are active

Fault	Cause
The lighting does not switch off automatically	<ul style="list-style-type: none"> - The switch-off delay time has not yet elapsed - Check whether the sensor head and mounting base are connected properly. In some cases <i>vandalism and sabotage protection</i> is active - <i>Time-dependent operating modes</i> are active
Lighting switches on automatically without movement	<ul style="list-style-type: none"> - There are objects in the field of detection, e.g. trees / bushes moved by the wind - <i>Time-dependent operating modes</i> are active
The lighting switches off automatically in twilight, despite movement	<ul style="list-style-type: none"> - The level of ambient light is above the configured brightness switching value - Lighting has been switched off manually - <i>Time-dependent operating modes</i> are active
Buttons do not work	<ul style="list-style-type: none"> - Device is still in the warm-up phase - The push button was used without the neutral conductor connected - The push button is not routed to the S terminal
The motion detector does not react	<ul style="list-style-type: none"> - No power supply; check the mains voltage.

10. Technical data

Mounting

Installation type	Surface mounting
Installation position	Wall / Ceiling
Connection	NYM 3x1.5 mm ² ... NYY 5x 2.5 mm ² Ø min. 2x 9 mm... Ø max. 2x 15 mm

Technical data

Housing

Dimensions	MD 200° 92 mm x 108 mm x 108 mm		
	MD 230° / MD 280° 92 mm x 108 mm x 138 mm		
Weight	MD 200° 228 g	MD 230° 260 g	MD 280° 260 g
Material	UV-resistant plastic		
Protection type	IP55		
Permissible ambient temperature	-25°C ... +50°C		
Relative humidity	10 - 90 %, non-condensing		
Impact resistance	IK07		
Colour	white, similar to RAL 9003 anthracite grey, similar to RAL 7016		

Electrical version

Protection class	II
Nominal voltage	220 - 240 V ~ / 50 - 60 Hz
Stand-by consumption	< 0.5 W
In-rush current	800 A / 200 µs

Sensors

Sensing range	200° horizontally rotatable + / - 30°, vertically tiltable by 10°		
	230° (2 x 115° separately adjustable) and 360° crawl protection		
Detection range diagonally	280° (3 x 95° separately adjustable) and 360° crawl protection		
	MD 200° Ø 24 m	MD 230° Ø 40 m	MD 280° Ø 40 m
Detection range head-on	MD 200° Ø 8 m	MD 230° Ø 10 m	MD 280° Ø 10 m

Technical data

Sensors

Detection range crawl protection	MD 200° –	MD 230° Ø 4 m	MD 280° Ø 4 m
Field of detection	MD 200° up to 252 m ²	MD 230° up to 804 m ²	MD 280° up to 979 m ²
Range adjustment	mechanical, electronic		
Rec. installation height	3 m		
Max. installation height	6 m		
Level of brightness	2 - 2000 lx		
Slave input	no		
Number of parallel switchable detectors	10		
Fully automatic	yes		
Semi-automatic	yes		
Twilight switch	yes		
Impulse feature	yes		
Switching delay from "dark to light" [s]	180 s		
Switching delay from "light to dark" [s]	60 s		

Control

Channel 1	Lighting
Interface	Switching
Contact	Normally open contact / non-floating
Switching capacity channel 1	230 V / 50 - 60 Hz 2300 W / 10 A (cos φ = 1), 1150 VA / 5 AX (cos φ = 0,5)
Zero-cross switching	yes
Switch-off delay time	1 s (pulse) - 240 min.
Push button input channel 1	1

11. Disposal



This device must not be disposed of as unsorted residual waste. Used devices must be disposed of correctly. Contact your local town council for more information.

12. EU Declaration of Conformity

CE declaration

The product complies with the following directives:

EMC 2014 / 30 / EU

LVD 2014 / 35 / EU

RoHS 2011 / 65 / EU

Reach 1907 / 2006 / EC

Ökodesign 2009 / 125 / EG

13. ESYLUX manufacturer's guarantee

The ESYLUX manufacturer's guarantee can be found on the relevant product page at www.esylux.com.