

B.E.G. LUXOMAT® PD9-1C-12-48V-FC

Installation and Operating Instruction for B.E.G. - Mini-Motion detector PD9-1C-12-48 V-FC

1. Product information

- Mini-Motion detector for indoor use
- Spring clips for quick and easy installation in suspended ceilings and lighting
- One channel to switch the lighting
- Simple setting on the device
- Power supply fits through hole for sensor part in ceiling (at 34 mm Ø)
- Including 45 mm cover ring and blinds

2. Operation

The occupancy detector controls the light automatically according to people present (movements) and the ambient brightness.

The integrated light sensor constantly measures the ambient light and compares it with the brightness level on the detector. If the ambient light is sufficient, lighting will not be switched. If the ambient light level is below the brightness level, a movement activated the lighting in the room.

The detector switches the light off instead of a person until the follow-up time do not recognized any movement in the room.

3. Safety information

Work on the 230 V mains supply may only be carried out by qualified professionals or by instructed persons under the direction and supervision of qualified skilled electrical personnel in accordance with electrotechnical regulations.



Disconnect supply before installing!



This device is not suitable for disconnection.

4a. Installation

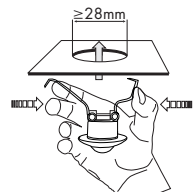

The detector has been designed and developed specifically for installation in suspended ceilings.

A circular opening of diameter min. 28 mm must be produced in the ceiling.

Having connected the cables in accordance with the regulations, connect the power supply via the RJ11 plug. Therefore, open the power supply with the help of the screws and close it afterwards. After that, put the power supply through the opening in the ceiling and mount the sensor onto the ceiling according to figure.

4b. Connecting terminals



4c. Self test cycle

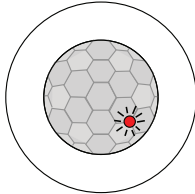

The LUXOMAT® PD9-1C-FC enters an initial 60-second self-test cycle, when the supply is first connected. The occupancy detector is ready for operation.

5. Exclude sources of interference

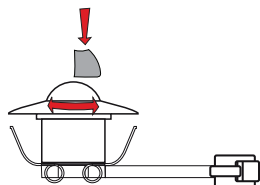

In case the sensing area of the LUXOMAT® PD9-1C-FC is too large or areas are being covered that should not be monitored, the range can be reduced or limited through use of the enclosed masking clips.

6. Putting into operation / Settings

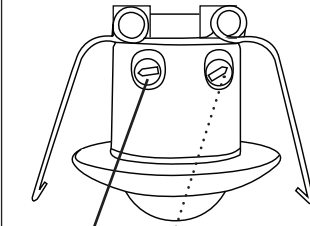

Twilight-switch for light control

The switch-on value for the light can be set at between 10 and 2000 Lux. Using the rotary control, the luminance set points can be set as desired

- Symbol ☾: Night-time operation
- Symbol ☀: Daytime/ Night-time operation



Follow-up time for light control

The time can be set infinitely variably at between 30 seconds and 30 minutes.

- Symbol ⏏: Impulse < 1 sec.
- Symbol TEST: Test mode

(Every movement switches on the light for a period of 1 second, switching it off for a period of 2 seconds after that regardless of the level of brightness)

7. Dimensions

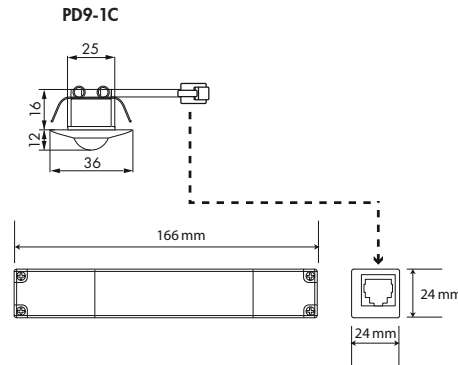

8. Article / Part-Nr. / Accessory

Typ	RAL9010
PD9-1C-FC	92985

- Accessory:**
- Wire basket BSK 92199
 - Coverring for PD9 (Ø 36 mm) white 92238
 - Coverring for PD9 (Ø 36 mm) silver 92237
 - Coverring for PD9 (Ø 36 mm) anthracite 92235

9. Range of Coverage

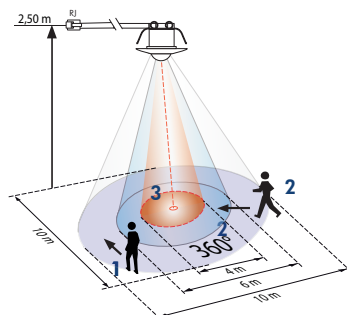

- 1 Walking across
- 2 Walking towards
- 3 Smaller motions

10. Technical data

Connection of sensor and power supply by means of telephone plug RJ11

Power supply: 12 - 48 V AC/DC

Power consumption: < 0,25 W

Ambient temperature: -25°C - +50°C

Degree of protection/class: IP20 / II / CE

Settings: Settings made manually by using potentiometer

Light values: 10 - 2000 Lux

Area of coverage: circular 360°

Range Ø H 2.50 m / T = 18°C:

seated 4 m/ tangential 10 m/ radial 6 m

Recommended height for mounting: 2 - 3 m

One channel to switch the lighting

Type of contact: NOC/with pretravel tungsten contact

Contact load: 10 A

Time-settings: 30 sec. - 30 min. / Test and Impuls

Dimensions

PD9-1C-FC Ø 36 x H 12 mm

Power supply L 165 x W 24 x H 24 mm

Declaration of Conformity: The product complies with the low voltage recommendation 2006/95/EC and the EMV recommendation 2004/108/EC.

11. Trouble shooting

1. Lamp does not light up

Lamp may be defect:

Replace lamps

No mains connection/power:

Check connection and mains fuse by qualified electrician

Incorrect setting of CDS twilight threshold:

Correct setting of CDS threshold

Lens of sensor unit obstructed by dirt or other objects:

Clean lens, remove objects

2. Lamp turns ON too late or detection range too small

LUXOMAT® PD9-1C-FC is mounted too high:

Note mounting height of 2.50 m.

3. Lamp stays ON continuously

Continuous thermal activity detected ie fan, central heating ducts, animals within detection area:

Remove heatsource. Check proper function of

LUXOMAT® PD9-1C-FC by covering the fresnel-lens. After expiry of delay timer, has to turn OFF lighting.

LUXOMAT® PD9-1C-FC connected in parallel to a manual over-ride switch:

Connect switch correctly

4. Unintended switching of light

Movement of heat source within detection area:

Check on presence of animals, fans or heaters

12. Wiring diagram

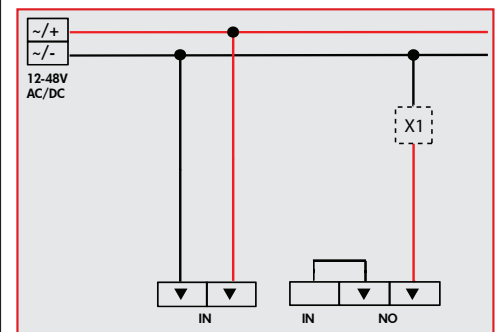

X1: Evaluation units/-devices